



# TOK



- ↳ Tok H150
- ↳ Tok C 270 H150
- ↳ Tok C H150
- ↳ Tok H400
- ↳ Tok C 270 H400
- ↳ Tok C H400
- ↳ Tok H700
- ↳ Tok C 270 H700
- ↳ Tok C H700
- ↳ Tok H1000
- ↳ Tok C 270 H1000
- ↳ Tok C H1000
- ↳ Tok Q H150
- ↳ Tok QL H150
- ↳ Tok Q2L H150
- ↳ Tok Q H400
- ↳ Tok QL H400
- ↳ Tok Q2L H400
- ↳ Tok Q H700
- ↳ Tok QL H700
- ↳ Tok Q2L H700
- ↳ Tok Q H1000
- ↳ Tok QL H1000
- ↳ Tok Q2L H1000

# TOK

The range

## ↘ Tok

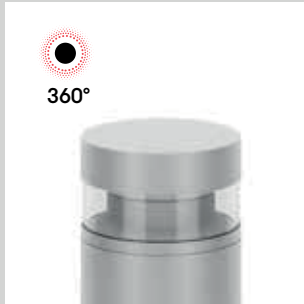

↘ Tok



↘ Tok C 270



↘ Tok C



**TOK**  
H150



**TOK**  
H400



**TOK**  
H700



**TOK**  
H1000



**TOK**  
C 270 H150



**TOK**  
C 270 H400



**TOK**  
C 270 H700



**TOK**  
C 270 H1000



**TOK**  
C H150



**TOK**  
C H400



**TOK**  
C H700



**TOK**  
C H1000

## ↘ Tok Q

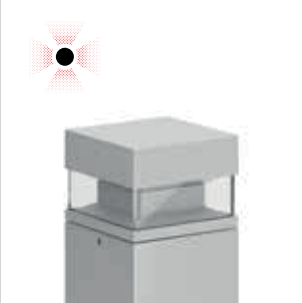

↘ Tok Q



↘ Tok QL



↘ Tok Q2L



**TOK Q**  
H150



**TOK Q**  
H400



**TOK Q**  
H700



**TOK Q**  
H1000



**TOK QL**  
H150



**TOK QL**  
H400



**TOK QL**  
H700



**TOK QL**  
H1000



**TOK Q2L**  
H150



**TOK Q2L**  
H400



**TOK Q2L**  
H700



**TOK Q2L**  
H1000

# TOK

## Installazione

Installation  
Installation  
Instalación

## Terra - Palo Ø60

Ground - Post Ø60  
Sol - Poteau Ø60  
Suelo - Poste Ø60

## Materiali

Materials  
Materiali  
Materiales

## Materiale Corpo: Alluminio | Tipo di diffusore: PMMA | Trattamento: Bordo Mare

Material: Aluminium | Diffuser type: PMMA | Treatment: Sea Treatment  
Matériel du corps: Aluminium | Type de diffuseur: PMMA | Traitement: Bord de Mer  
Material del cuerpo: Aluminio | Tipo de difusor: PMMA | Tratamiento: Tratamiento marino

## Alimentazione

Power supply  
Alimentation  
Alimentación

220-240 V

## Versioni

Versions  
Versions  
Versiones

## Cavo Alimentazione: 1 metro H05RN-F

Power cable: 1 m H05RN-F  
Câble d'alimentation: 1 m H05RN-F  
Cable de alimentación: 1 m H05RN-F



360°



**TOK**  
H150



270°



**TOK**  
C 270 H150



180°



**TOK**  
C H150



360°



**TOK**  
H400



270°



**TOK**  
C 270 H400



180°



**TOK**  
C H400



360°



**TOK**  
H700



270°



**TOK**  
C 270 H700



180°



**TOK**  
C H700



360°



**TOK**  
H1000



270°



**TOK**  
C 270 H1000



180°



**TOK**  
C H1000



## COLOURS



White RAL 9010



Grey High Tech RAL 9006









Grey anthracite RAL 7021







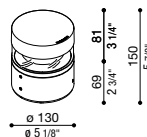

Corten

### Tok H150

<b>IP 66</b> <b>IK 10 20J xx9 CE UK CA</b>  360°	LED			COL. CODE *  LL128024 <input type="checkbox"/>  LL128003 <input type="checkbox"/>  LL128004 <input type="checkbox"/>  LL128005 <input type="checkbox"/>	 220-240 V	 ø 130 ø 5 1/8"
	W	LM	REAL LM			
	14	1860	650			

\* Complete the CODE     LED COLOUR    N | 4000K    3 | 3000K    2 | 2700K    1 | 2200K



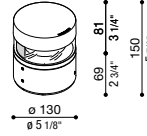



### Tok C 270 H150

<b>IP 66</b> <b>IK 10 20J xx9 CE UK CA</b>  270°	LED			COL. CODE *  LL128060 <input type="checkbox"/>  LL128061 <input type="checkbox"/>  LL128062 <input type="checkbox"/>  LL128063 <input type="checkbox"/>	 220-240 V	 ø 130 ø 5 1/8"
	W	LM	REAL LM			
	8	930	240			

\* Complete the CODE     LED COLOUR    N | 4000K    3 | 3000K    2 | 2700K    1 | 2200K

Fascio luminoso: 270° | Light beam: 270° | Faisceau lumineux : 270° | Haz de luz: 270°



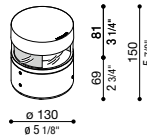



### Tok C H150

<b>IP 66</b> <b>IK 10 20J xx9 CE UK CA</b>  180°	LED			COL. CODE *  LL128023 <input type="checkbox"/>  LL128000 <input type="checkbox"/>  LL128001 <input type="checkbox"/>  LL128002 <input type="checkbox"/>	 220-240 V	 ø 130 ø 5 1/8"
	W	LM	REAL LM			
	8	930	200			

\* Complete the CODE     LED COLOUR    N | 4000K    3 | 3000K    2 | 2700K    1 | 2200K





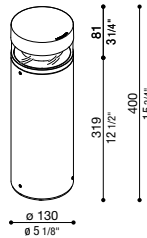

Fascio luminoso: 180° | Light beam: 180° | Faisceau lumineux : 180° | Haz de luz: 180°

### Tok H400

<b>IP 66</b> <b>IK 10 20J xx9 CE UK CA</b>  360°	LED			COL. CODE *  LL128032 <input type="checkbox"/>  LL128009 <input type="checkbox"/>  LL128010 <input type="checkbox"/>  LL128011 <input type="checkbox"/>	 220-240 V	 ø 130 ø 5 1/8"
	W	LM	REAL LM			
	14	1860	650			

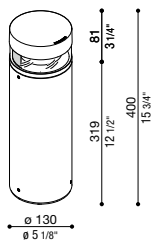
\* Complete the CODE     LED COLOUR    N | 4000K    3 | 3000K    2 | 2700K    1 | 2200K







## Tok C 270 H400

<b>IP66</b> <b>IK 10 20J xx9</b>  	LED			 <b>220-240 V</b>	COL.	CODE *	
	W	LM	REAL LM				
	8	930	240		 LL128064 <input type="checkbox"/>  LL128065 <input type="checkbox"/>  LL128066 <input type="checkbox"/>  LL128067 <input type="checkbox"/>		

\* Complete the CODE  LED COLOUR N | 4000K 3 | 3000K 2 | 2700K 1 | 2200K

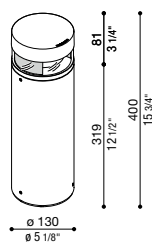
Fascio luminoso: 270° | Light beam: 270° | Faisceau lumineux : 270° | Haz de luz: 270°







## Tok C H400

<b>IP66</b> <b>IK 10 20J xx9</b>  	LED			 <b>220-240 V</b>	COL.	CODE *	
	W	LM	REAL LM				
	8	930	200		 LL128033 <input type="checkbox"/>  LL128006 <input type="checkbox"/>  LL128007 <input type="checkbox"/>  LL128008 <input type="checkbox"/>		

\* Complete the CODE  LED COLOUR N | 4000K 3 | 3000K 2 | 2700K 1 | 2200K

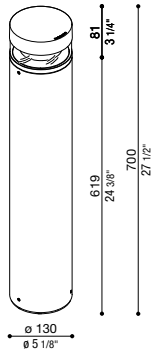





Fascio luminoso: 180° | Light beam: 180° | Faisceau lumineux : 180° | Haz de luz: 180°

## Tok H700

<b>IP66</b> <b>IK 10 20J xx9</b>  	LED			 <b>220-240 V</b>	COL.	CODE *	
	W	LM	REAL LM				
	14	1860	650		 LL128018 <input type="checkbox"/>  LL128015 <input type="checkbox"/>  LL128016 <input type="checkbox"/>  LL128017 <input type="checkbox"/>		

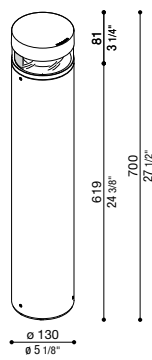
\* Complete the CODE  LED COLOUR N | 4000K 3 | 3000K 2 | 2700K 1 | 2200K







## Tok C 270 H700

<b>IP66</b> <b>IK 10 20J xx9</b>  	LED			 <b>220-240 V</b>	COL.	CODE *	
	W	LM	REAL LM				
	8	930	240		 LL128068 <input type="checkbox"/>  LL128069 <input type="checkbox"/>  LL128070 <input type="checkbox"/>  LL128071 <input type="checkbox"/>		

\* Complete the CODE  LED COLOUR N | 4000K 3 | 3000K 2 | 2700K 1 | 2200K

Fascio luminoso: 270° | Light beam: 270° | Faisceau lumineux : 270° | Haz de luz: 270°

### Tok C H700



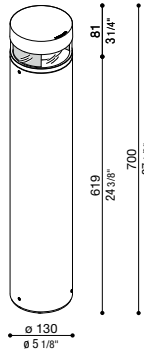



<b>IP66</b> <b>IK 10 20J xx9 CE UK CA</b>  180°	LED			COL. CODE *  LL128020 <input type="checkbox"/>  LL128012 <input type="checkbox"/>  LL128013 <input type="checkbox"/>  LL128014 <input type="checkbox"/>
	W	LM	REAL LM	
8	930	200	  <b>220-240 V</b>	



\* Complete the CODE     LED COLOUR    N | 4000K    3 | 3000K    2 | 2700K    1 | 2200K

Fascio luminoso: 180° | Light beam: 180° | Faisceau lumineux: 180° | Haz de luz: 180°





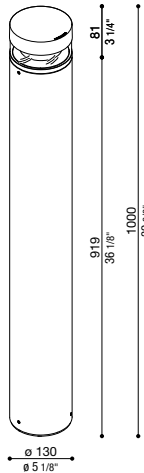

### Tok H1000

<b>IP66</b> <b>IK 10 20J xx9 CE UK CA</b>  360°	LED			COL. CODE *  LL128051 <input type="checkbox"/>  LL128052 <input type="checkbox"/>  LL128053 <input type="checkbox"/>  LL128054 <input type="checkbox"/>
	W	LM	REAL LM	
14	1860	650	  <b>220-240 V</b>	



\* Complete the CODE     LED COLOUR    N | 4000K    3 | 3000K    2 | 2700K    1 | 2200K

### Tok C 270 H1000

<b>IP66</b> <b>IK 10 20J xx9 CE UK CA</b>  270°	LED			COL. CODE *  LL128072 <input type="checkbox"/>  LL128073 <input type="checkbox"/>  LL128074 <input type="checkbox"/>  LL128075 <input type="checkbox"/>
	W	LM	REAL LM	
8	930	240	  <b>220-240 V</b>	

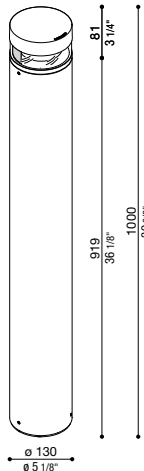

\* Complete the CODE     LED COLOUR    N | 4000K    3 | 3000K    2 | 2700K    1 | 2200K

Fascio luminoso: 270° | Light beam: 270° | Faisceau lumineux: 270° | Haz de luz: 270°

## Tok C H1000

IP66 IK 10 20J xx9 CE UK CA	LED			220-240 V	COL.	CODE *	
	W	LM	REAL LM				
	8	930	200			LL128047	
						LL128048	
						LL128049	
						LL128050	

\* Complete the CODE  LED COLOUR N | 4000K 3 | 3000K 2 | 2700K 1 | 2200K

Fascio luminoso: 180° | Light beam: 180° | Faisceau lumineux : 180° | Haz de luz: 180°

## Accessori | Accessories | Accessoires | Accesorios

### Staffa Tok in acciaio

Tok steel fixing base

Base de fixation en acier pour Tok

Base de fijación de acero para Tok

Col. Code  
LB128003

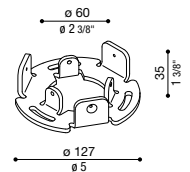

### Morsettiera coassiale 3 poli

Morsettiera coassiale a 3 poli, IP68, per cavo ø 7/12 mm.

3-pole coaxial terminal block

3-pole coaxial terminal block, IP68, for cable ø 7/12 mm.

Bornier coaxial à 3 pôles

Bornier coaxial à 3 pôles, IP68, pour câble ø 7/12 mm.

Bloque de terminales coaxiales de 3 polos

Bloque de terminales coaxiales de 3 polos, IP68, para cable ø 7/12 mm.

Col. Code  
LB11293

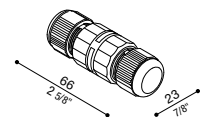

### Morsettiera lineare a 3 vie

Morsettiera lineare a 3 vie a 3 poli, IP68, per cavo ø 7/13,5 mm.

3 way linear terminal block

3-way 3-pole linear terminal block, IP68, for cable Ø 7/13.5 mm.

Bornier linéaire 3 voies

Bornier linéaire 3 voies à 3 pôles, IP68, pour câble diam. 7/13,5 mm

Caja de bornes lineal de 3 vías

Caja de bornes lineal de 3 vías y de 3 polos, IP68, para cable con ø 7/13,5 mm.

Col. Code  
LB11294

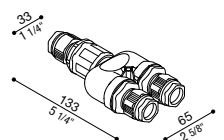



TOK H700



# TOK Q

## Installazione

Installation  
Installation  
Instalación

## Terra - Palo Ø60

Ground - Post Ø60  
Sol - Poteau Ø60  
Suelo - Poste Ø60

## Materiali

Materials  
Materiali  
Materiales

## Materiale Corpo: Alluminio | Tipo di diffusore: PMMA | Trattamento: Bordo Mare

Material: Aluminium | Diffuser type: PMMA | Treatment: Sea Treatment  
Matériel du corps: Aluminium | Type de diffuseur: PMMA | Traitement: Bord de Mer  
Material del cuerpo: Aluminio | Tipo de difusor: PMMA | Tratamiento: Tratamiento marino

## Alimentazione

Power supply  
Alimentation  
Alimentación

220-240 V

## Versioni

Versions  
Versions  
Versiones

## Cavo Alimentazione: 1 metro H05RN-F

Power cable: 1 m H05RN-F  
Câble d'alimentation: 1 m H05RN-F  
Cable de alimentación: 1 m H05RN-F



**TOK Q**  
H150



**TOK QL**  
H150



**TOK Q2L**  
H150



**TOK Q**  
H400



**TOK QL**  
H400



**TOK Q2L**  
H400



**TOK Q**  
H700



**TOK QL**  
H700



**TOK Q2L**  
H700



**TOK Q**  
H1000



**TOK QL**  
H1000



**TOK Q2L**  
H1000

## COLOURS



White RAL 9010



Grey High Tech RAL 9006







Grey anthracite RAL 7021



Corten

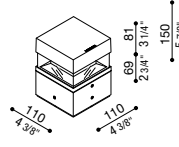

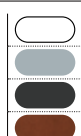

### Tok Q H150

<b>IP66</b> <b>IK 10 20J xx9</b> 	LED			 <b>220-240 V</b>	<b>COL.</b>	<b>CODE *</b>	
	W	LM	REAL LM				
	14	1920	630		<b>LL12810W</b> □ <b>LL12810G</b> □ <b>LL12810E</b> □ <b>LL12810K</b> □		

\* Complete the CODE     LED COLOUR    N | 4000K    3 | 3000K    2 | 2700K    1 | 2200K



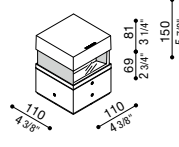

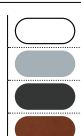
Emissione luminosa 360°. | Light beam 360°. | Angle d'éclairage 360°. | Emisión de luz 360°.

### Tok QL H150

<b>IP66</b> <b>IK 10 20J xx9</b> 	LED			 <b>220-240 V</b>	<b>COL.</b>	<b>CODE *</b>	
	W	LM	REAL LM				
	5	480	140		<b>LL12811W</b> □ <b>LL12811G</b> □ <b>LL12811E</b> □ <b>LL12811K</b> □		



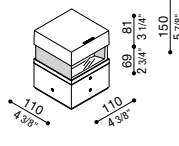

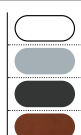
\* Complete the CODE     LED COLOUR    N | 4000K    3 | 3000K    2 | 2700K    1 | 2200K

### Tok Q2L H150

<b>IP66</b> <b>IK 10 20J xx9</b> 	LED			 <b>220-240 V</b>	<b>COL.</b>	<b>CODE *</b>	
	W	LM	REAL LM				
	8	960	180		<b>LL12812W</b> □ <b>LL12812G</b> □ <b>LL12812E</b> □ <b>LL12812K</b> □		

\* Complete the CODE     LED COLOUR    N | 4000K    3 | 3000K    2 | 2700K    1 | 2200K

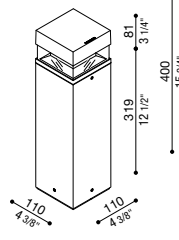

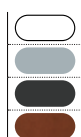
### Tok Q H400

<b>IP66</b> <b>IK 10 20J xx9</b> 	LED			 <b>220-240 V</b>	<b>COL.</b>	<b>CODE *</b>	
	W	LM	REAL LM				
	14	1920	630		<b>LL12813W</b> □ <b>LL12813G</b> □ <b>LL12813E</b> □ <b>LL12813K</b> □		

\* Complete the CODE     LED COLOUR    N | 4000K    3 | 3000K    2 | 2700K    1 | 2200K

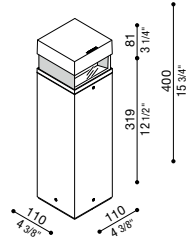

Emissione luminosa 360°. | Light beam 360°. | Angle d'éclairage 360°. | Emisión de luz 360°.

## Tok QL H400

<b>IP66</b> <b>IK 10 20J xx9 CE UK CA</b>	LED				<b>COL.</b> <b>CODE *</b>	
	W	LM	REAL LM			
	5	480	140	  <b>220-240 V</b>	<input type="checkbox"/> LL12814W <input type="checkbox"/> LL12814G <input type="checkbox"/> LL12814E <input type="checkbox"/> LL12814K	

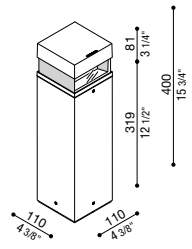

\* Complete the CODE     LED COLOUR    N | 4000K    3 | 3000K    2 | 2700K    1 | 2200K

## Tok Q2L H400

<b>IP66</b> <b>IK 10 20J xx9 CE UK CA</b>	LED				<b>COL.</b> <b>CODE *</b>	
	W	LM	REAL LM			
	8	960	180	  <b>220-240 V</b>	<input type="checkbox"/> LL12815W <input type="checkbox"/> LL12815G <input type="checkbox"/> LL12815E <input type="checkbox"/> LL12815K	

\* Complete the CODE     LED COLOUR    N | 4000K    3 | 3000K    2 | 2700K    1 | 2200K

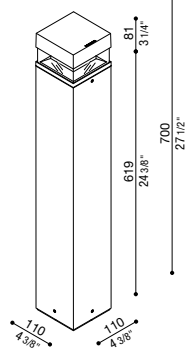

## Tok Q H700

<b>IP66</b> <b>IK 10 20J xx9 CE UK CA</b>	LED				<b>COL.</b> <b>CODE *</b>	
	W	LM	REAL LM			
	14	1920	630	  <b>220-240 V</b>	<input type="checkbox"/> LL12816W <input type="checkbox"/> LL12816G <input type="checkbox"/> LL12816E <input type="checkbox"/> LL12816K	

\* Complete the CODE     LED COLOUR    N | 4000K    3 | 3000K    2 | 2700K    1 | 2200K

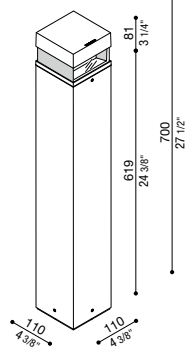

Emissione luminosa 360°. | Light beam 360°. | Angle d'éclairage 360°. | Emisión de luz 360°.

## Tok QL H700

<b>IP66</b> <b>IK 10 20J xx9 CE UK CA</b>	LED				<b>COL.</b> <b>CODE *</b>	
	W	LM	REAL LM			
	5	480	140	  <b>220-240 V</b>	<input type="checkbox"/> LL12817W <input type="checkbox"/> LL12817G <input type="checkbox"/> LL12817E <input type="checkbox"/> LL12817K	

\* Complete the CODE     LED COLOUR    N | 4000K    3 | 3000K    2 | 2700K    1 | 2200K

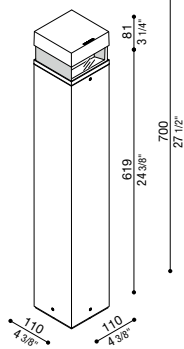

### Tok Q2L H700

<b>IP66</b> <b>IK 10 20J xx9</b> 	LED				<b>W</b> <b>LM</b> <b>REAL LM</b>	 <b>220-240 V</b>	<b>COL.</b> <b>CODE *</b>
	8	960	180				



\* Complete the CODE    LED COLOUR   N | 4000K   3 | 3000K   2 | 2700K   1 | 2200K

### Tok Q H1000

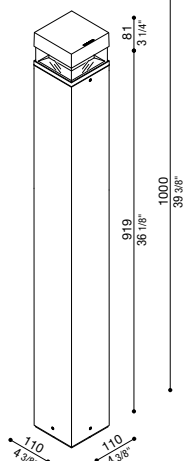

<b>IP66</b> <b>IK 10 20J xx9</b> 	LED				<b>W</b> <b>LM</b> <b>REAL LM</b>	 <b>220-240 V</b>	<b>COL.</b> <b>CODE *</b>
	14	1920	630				



\* Complete the CODE    LED COLOUR   N | 4000K   3 | 3000K   2 | 2700K   1 | 2200K

Emissione luminosa 360°. | Light beam 360°. | Angle d'éclairage 360°. | Emisión de luz 360°.

### Tok QL H1000

<b>IP66</b> <b>IK 10 20J xx9</b> 	LED				<b>W</b> <b>LM</b> <b>REAL LM</b>	 <b>220-240 V</b>	<b>COL.</b> <b>CODE *</b>
	5	480	140				

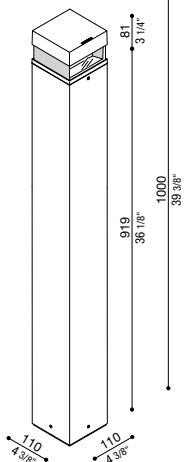

\* Complete the CODE    LED COLOUR   N | 4000K   3 | 3000K   2 | 2700K   1 | 2200K

## Tok Q2L H1000

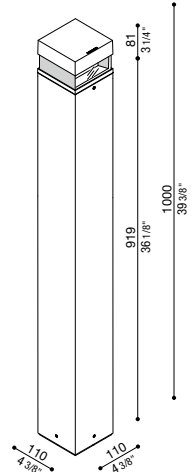
IP66 IK 10 20J xx9 CE UK CA	LED			220-240 V	COL.	CODE *
	W	LM	REAL LM			
	8	960	180	⊕ ⊙	<input type="checkbox"/> LL12821W <input type="checkbox"/> LL12821G <input type="checkbox"/> LL12821E <input type="checkbox"/> LL12821K	

\* Complete the CODE  LED COLOUR N | 4000K 3 | 3000K 2 | 2700K 1 | 2200K

## Accessori | Accessories | Accessoires | Accesorios

### Staffa Tok Q in acciaio

Tok Q steel fixing base

Base de fixation en acier pour Tok Q

Base de fijación de acero para Tok Q

Col. Code

LB1280004

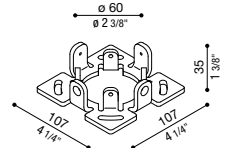

### Morsettiera coassiale 3 poli

Morsettiera coassiale a 3 poli, IP68, per cavo ø 7/12 mm.

3-pole coaxial terminal block

3-pole coaxial terminal block, IP68, for cable ø 7/12 mm.

Bornier coaxial à 3 pôles

Bornier coaxial à 3 pôles, IP68, pour câble ø 7/12 mm.

Bloque de terminales coaxiales de 3 polos

Bloque de terminales coaxiales de 3 polos, IP68, para cable ø 7/12 mm.

Col. Code

LB11293

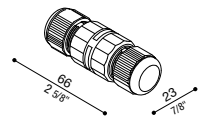

### Morsettiera lineare a 3 vie

Morsettiera lineare a 3 vie a 3 poli, IP68, per cavo ø 7/13,5 mm.

3 way linear terminal block

3-way 3-pole linear terminal block, IP68, for cable Ø 7/13.5 mm.

Bornier linéaire 3 voies

Bornier linéaire 3 voies à 3 pôles, IP68, pour câble diam. 7/13,5 mm

Caja de bornes lineal de 3 vías

Caja de bornes lineal de 3 vías y de 3 polos, IP68, para cable con ø 7/13,5 mm.

Col. Code

LB11294

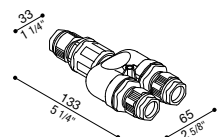



# FEATURES

## Predisposto per installazione su palo da Ø60 mm standard

Suitable for installation on standard post Ø60 mm  
 Prédisposé pour l'installation sur Poteau standard Ø60 mm  
 Instalable en poste estándar Ø60 mm

### ↘ TOK



### ↘ TOK Q



### TOK

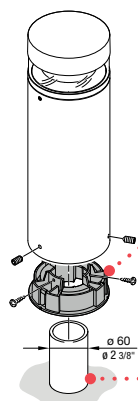

**Base di fissaggio compresa**  
 Fixing base included  
 Base de fixation incluse  
 Base de fijación incluida

**Palo da Ø60 mm standard**  
 Ø60 mm standard post  
 Standard Poteau Ø60 mm  
 Poste estándar Ø60 mm

### TOK Q

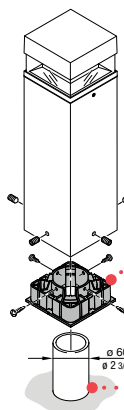

**Base di fissaggio compresa**  
 Fixing base included  
 Base de fixation incluse  
 Base de fijación incluida

**Palo da Ø60 mm standard**  
 Ø60 mm standard post  
 Standard Poteau Ø60 mm  
 Poste estándar Ø60 mm

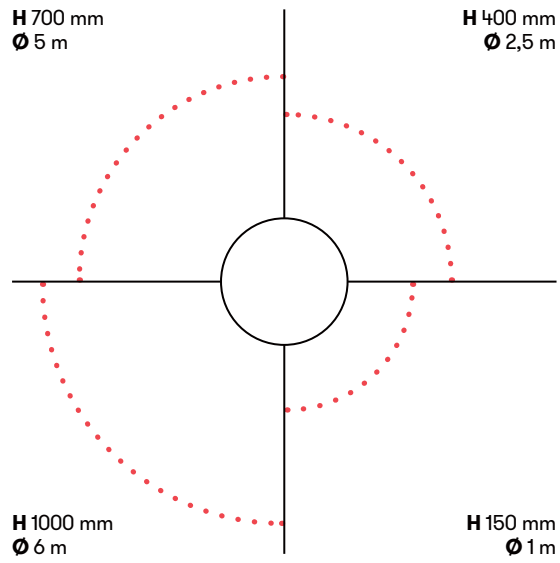
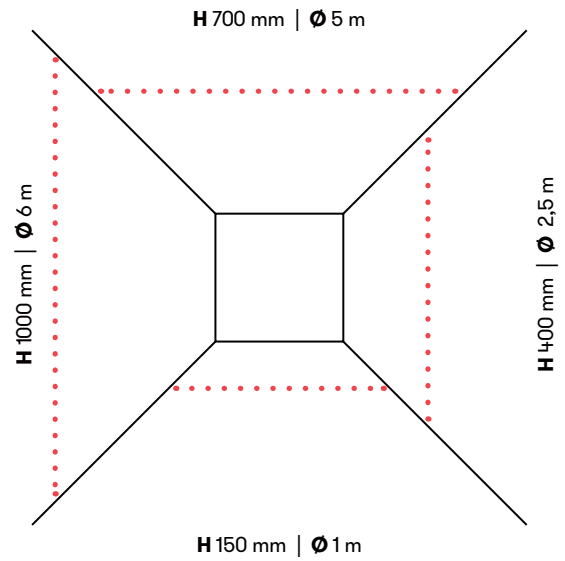

## FEATURES

**TOK****TOK Q**

**Scegliendo diverse altezze, varia l'area illuminata.**

By choosing different heights, the lit area changes.

En choisissant des hauteurs différentes, la zone éclairée change.

Eligiendo diferentes alturas, la superficie iluminada varía.

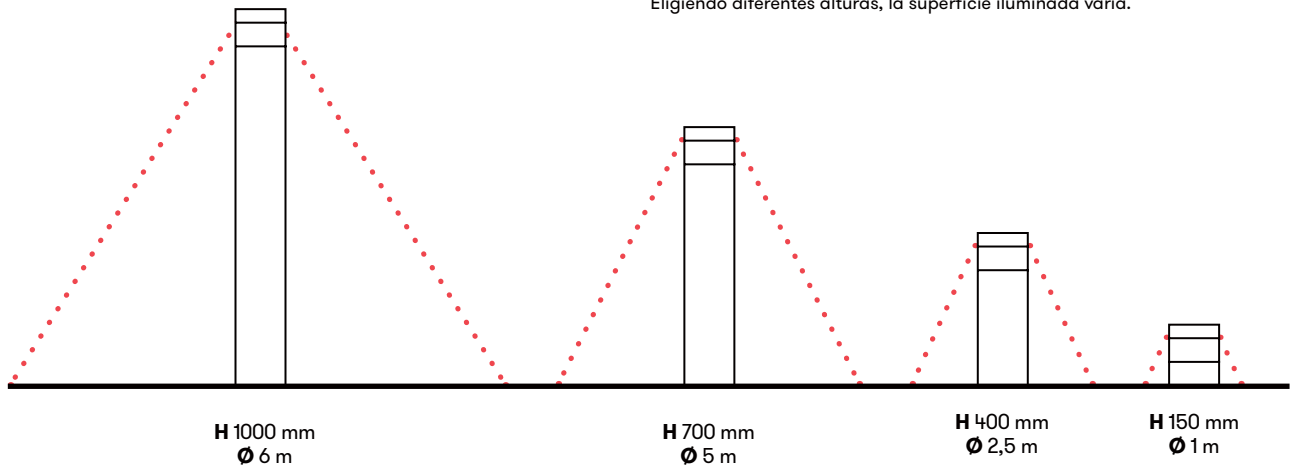

**TOK Q**





**Colori disponibili.**  
Available colours.  
Couleurs disponibles.  
Colores disponibles.

TOK C 270 H150



TOK C 270 H150





TOK H150



TOK H150



TOK H400

TOK Ø H150



TOK Ø H150



TOK Q1 H400



TOK Q1 H700

