

STILE NEXT

- ↘ Stile next 503
- ↘ Stile next 503 asimmetrica
- ↘ Stile next 506L
- ↘ Stile next 506L asimmetrica
- ↘ Stile next 506L asimmetrica orizzontale
- ↘ Stile next 506E
- ↘ Stile next 103
- ↘ Stile next 103 asimmetrica
- ↘ Stile next 106L
- ↘ Stile next 106L asimmetrica
- ↘ Stile next 106L asimmetrica orizzontale
- ↘ Stile next 106E
- ↘ Stile next zero 60T
- ↘ Stile next zero power 60T
- ↘ Stile next zero 60Q
- ↘ Stile next zero power 60Q
- ↘ Stile next zero 120T
- ↘ Stile next zero power 120T
- ↘ Stile next zero 120Q
- ↘ Stile next zero power 120Q
- ↘ Stile next 260
- ↘ Kit-01 Stile Next Post
- ↘ Kit-02 Stile Next Post
- ↘ Kit-05 Stile Next Post
- ↘ Kit-06 Stile Next Post
- ↘ Kit-11 Stile Next Post
- ↘ Kit-12 Stile Next Post

STILE NEXT

The range

INCASSO A MURO CON SCATOLA STANDARD

Installation with wall recessed box
Encastrement dans le mur avec boîte standards
Instalación empotrada en pared con caja estándar

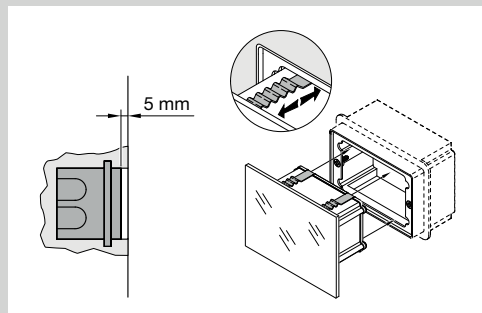

503

506E

506L

Scatole Standard
Recessed box
Boîte standards
Cajas de empotrar estándar

Incasso a muro con scatola.
Consigliato incassare la scatola di 5 mm rispetto alla parete per agevolare l'installazione.

Wall recessed fixture. It is advisable to mount the box with a 5mm. recess compared with the wall to facilitate installation.

Encastrement mural. Il est conseillé d'encaisser la boîte de 5mm par rapport au mur pour faciliter l'installation.

Empotrado en pared con caja. Se recomienda empotrar la caja a 5 mm de la a la pared para facilitar la instalación.

INCASSO A MURO ED IN CARTONGESSO

Recessed in wall and plasterboard
Encastrement dans le mur et dans le placoplâtre
Empotrado en pared y falso techo

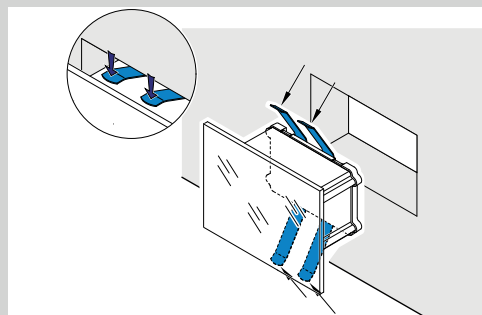

SENZA UTENSILI | Massima praticità per il montaggio ad incasso, che avviene semplicemente tramite sistema ad incastro adattabile alle diverse esigenze di profondità.

TOOL FREE | Maximum practicality for the flush-fitting assembly consisting of a recessed system that can be adapted to suit various depths.

SANS OUTILS | Grande facilité pour le montage par encastrement que l'on réalise de façon très simple au moyen d'un système d'encastrement qui s'adapte aux différentes exigences de profondeur.

SIN HERRAMIENTAS | Máxima facilidad para el montaje empotrado, que se realiza simplemente mediante un sistema de enclavamiento, adaptable a diferentes necesidades de profundidad.

Incasso a muro ed in cartongesso senza l'utilizzo di scatola.

Recessed in wall and plasterboard without any box.

Encastrement dans le mur et dans le placoplâtre sans utilisation de boîte.

Empotrado en pared y falso techo sin caja.



503



506E



506L



**503
ASIMMETRICA**



**506L
ASIMMETRICA**



**506L
ASIMMETRICA ORIZZONTALE**



103



106E



106L



**103
ASIMMETRICA**



**106L
ASIMMETRICA**



**106L
ASIMMETRICA ORIZZONTALE**

STILE NEXT

Installazione

Installation
Installation
Instalación

Incasso parete

Wall recess
Encastrement au mur
Empotrar pared

Materiali

Materials
Materiali
Materiales

Materiale Corpo: Alluminio | Tipo di diffusore: Vetro serigrafato

Material: Aluminium | Diffuser type: Serigraphed glass
Matériel du corps: Aluminium | Type de diffuseur: Verre sérigraphié
Material del cuerpo: Aluminio | Tipo de difusor: Vidro serigrafiado

Alimentazione

Power supply
Alimentation
Alimentación

220-240 V



STILE NEXT
503



STILE NEXT
503 ASIMMETRICO



STILE NEXT
506L



STILE NEXT
506L ASIMMETRICO



STILE NEXT
506L ASIMMETRICO
ORIZZONTALE



STILE NEXT
506E

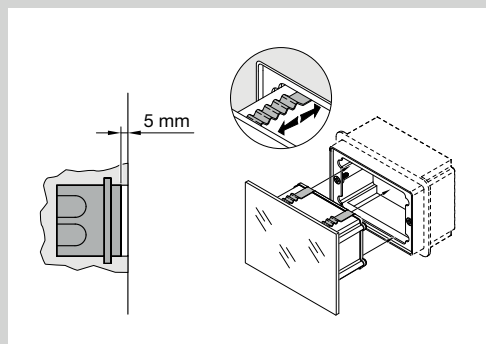

Incasso a muro con scatola.

Consigliato incassare la scatola di 5 mm rispetto alla parete per agevolare l'installazione.

Wall recessed fixture. It is advisable to mount the box with a 5mm. recess compared with the wall to facilitate installation.

Encastrement mural. Il est conseillé d'encaisser la boîte de 5mm par rapport au mur pour faciliter l'installation.

Empotrado en pared con caja. Se recomienda empotrar la caja a 5 mm de la a la pared para facilitar la instalación.

COLOURS



Black serigraphy



Grey High Tech Serigraphy



Corten serigraphy



Neutral

Stile Next 503

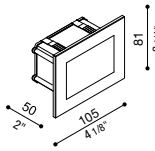
IP66 IK 06 1J xx3 CE UK CA	LED			COL.	CODE *	
	W	LM	REAL LM			
	3	310	68		LL641C□ LL641C2□ LL641CG□ LL641CK□	
	6	720	170		LL641D□	

* Complete the CODE LED COLOUR N | 4000K 3 | 3000K 2 | 2700K, only for 3W version

Predisposto per singolo ingresso alimentazione. Versione a 6W, cod. LL641D_, non disponibile in 2700K. | Single cable entry at the back. 6W version, code LL641D_, not available in 2700K. | Entrée d'alimentation simple. Version 6W, code LL641D_, non disponible en 2700K. | Preparado para la entrada de una única alimentación. Versión de 6W, código LL641D_, no disponible en 2700K.

Stile Next 503 Asimmetrico

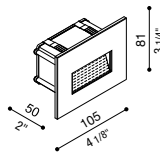
IP66 IK 06 1J xx3 CE UK CA	LED			COL.	CODE *	
	W	LM	REAL LM			
	3	310	45		LL643C□ LL643C2□ LL643CG□ LL643CK□	

* Complete the CODE LED COLOUR N | 4000K 3 | 3000K 2 | 2700K

Predisposto per singolo ingresso alimentazione. Deflettore in alluminio primario pressofuso EN-AB44100. | Single cable entry at the back. Reflector made of EN-AB44100 die-cast aluminium primary alloy. | Entrée d'alimentation simple. Réflecteur en aluminium primaire injecté EN-AB44100. | Preparado para la entrada de una única alimentación. Reflector de fundición de aluminio primario EN-AB44100.



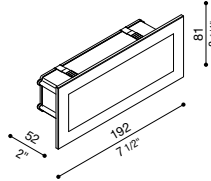

Stile Next 506L

IP66 IK 06 1J xx3 CE UK CA	LED			COL.	CODE *	
	W	LM	REAL LM			
	6	720	217		LL661D□ LL661D2□ LL661DG□ LL661DK□	

* Complete the CODE LED COLOUR N | 4000K 3 | 3000K 2 | 2700K

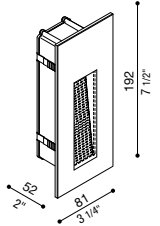
Predisposto per doppio ingresso alimentazione. | Double cable entry at the back. | Possibilità alimentazione double entrée. | Preparado para doble entrada de alimentación.







Stile Next 506L Asimmetrico

IP66 IK 06 1J xx3 CE UK EN	LED			COL.	CODE *	
	W	LM	REAL LM			
	3	310	38		LL663C□	
				 	220-240 V	

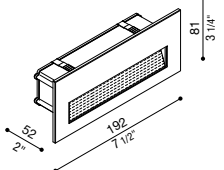
* Complete the CODE LED COLOUR N | 4000K 3 | 3000K

Predisposto per doppio ingresso alimentazione. Deflettore in alluminio primario pressofuso EN-AB44100. | Double cable entry at the back. Reflector made of EN-AB44100 die-cast aluminium primary alloy. | Possibilità alimentazione double entrée. Réflecteur en aluminium primaire injecté EN-AB44100. | Preparado para doble entrada de alimentación. Reflector de fundición de aluminio primario EN-AB44100.





Stile Next 506L Asimmetrico Orizzontale

IP66 IK 06 1J xx3 CE UK EN	LED			COL.	CODE *	
	W	LM	REAL LM			
	4	490	70		LL665F□	
					LL665F2□	
					LL665FG□	
					LL665FK□	
				 	220-240 V	

* Complete the CODE LED COLOUR N | 4000K 3 | 3000K 2 | 2700K

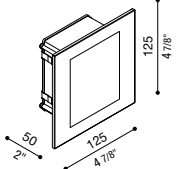
Predisposto per doppio ingresso alimentazione. Deflettore in alluminio primario pressofuso EN-AB44100. | Double cable entry at the back. Reflector made of EN-AB44100 die-cast aluminium primary alloy. | Possibilità alimentazione double entrée. Réflecteur en aluminium primaire injecté EN-AB44100. | Preparado para doble entrada de alimentación. Reflector de fundición de aluminio primario EN-AB44100.

Stile Next 506E

IP66 IK 06 1J xx3 CE UK EN	LED			COL.	CODE *	
	W	LM	REAL LM			
	6	720	283		LL651D□	
				 	220-240 V	

* Complete the CODE LED COLOUR N | 4000K 3 | 3000K

Predisposto per doppio ingresso alimentazione. | Double cable entry at the back. | Possibilità alimentazione double entrée. | Preparado para doble entrada de alimentación.

Palo Stile Next

Palo multifunzionale in tecnopolimero completo di coperchi amovibili (da asportare nel caso si applichino apparecchi) e relativa bulloneria. Obbligatoria l'installazione del modello 506-L, non compreso. Predisposto per accogliere anche un coperchio per presa elettrica della Bticino mod. IDROBOX LUNA IP55 - Cod. 24602L.

Post Stile Next



Multi-purpose technopolymer post complete with removable covers (to be removed to accommodate the light fixtures) and all required nuts and bolts. Model 506L must be mounted (article to be ordered separately). It has been designed to accommodate an IP rated electric socket manufactured by Bticino mod. IDROBOX LUNA IP55 - Code 24602L.

Poteau Stile Next

Poteau multifonctionnel en technopolymère avec couvercles amovibles (à retirer pour appliquer les appareils) et visserie. L'installation du modèle 506-L, non compris, est obligatoire. Il a été également conçu pour l'application d'un couvercle de la prise de courant Bticino mod. IDROBOX LUNA IP55 - Cod. 24602L.

Poste Stile Next

Poste multifuncional de tecnopolímero con tapas amovibles (a retirar en el caso de que se apliquen aparatos) y la tornillería correspondiente. Obligatoria la instalación del modelo 506-L, no comprendido. Diseñado para alojar una toma de corriente eléctrica IP fabricada por Bticino mod. IDROBOX LUNA IP55 - Código 24602L.

Col.	Code
	LB11652
	LB1165G
	LB1165K

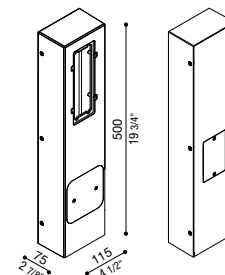



Palo Stile Next Alluminio



Palo multifunzionale per modelli Stile Next 503 - Stile Next 503 asimmetrico. Adatto per uso esterno, idoneo per applicazioni a pavimento. Struttura palo realizzata in alluminio pressofuso; elevata resistenza all'ossidazione grazie al trattamento di passivazione a base di zirconio e alla verniciatura con resine poliestere stabilizzata ai raggi UV. Bulloneria inclusa. BORDO MARE: aggiungi S alla fine del codice selezionato comprensivo di colore LED per avere il prodotto fornito con trattamento bordo mare contro le nebbie saline.



Versione monoemissione

Col.	Code
	LB1100000
	LB1100002
	LB1100001

Versione biemissione

Col.	Code
	LB1100003
	LB1100005
	LB1100004

Aluminium Post Stile Next

Multi-purpose post for Stile Next 503 - Stile Next 503 asimmetrico. Suitable for outdoor use and floor installation. Post in die-cast aluminium; highly resistant to oxidization thanks to the zirconium-based passivation treatment and UV stabilized polyester resin coating. Nuts and bolts included. BORDO MARE: add S to the end of the selected code including LED colour to have the product supplied with sea treatment against salt spray.

Poteau aluminium pour Stile Next

Poteau multifonctionnel pour Stile Next 503 - Stile Next asimmetrico. Adapté à l'usage à l'extérieur et pour une application au sol. Poteau réalisé en aluminium injecté; haute résistance à l'oxydation, grâce à un traitement de passivation à base de zirconium et laquage poudre à base de résines polyesters, fixées aux rayons UV. Fixation comprise.

BORDO MARE: ajoutez S à la fin du code sélectionné, y compris la couleur LED, pour que le produit soit fourni avec un traitement de bord de mer contre le brouillard salin.

Poste de aluminio por Stile Next

Poste multifuncional por Stile Next 503 - Stile Next asimmetrico. Adecuado para uso exterior y para aplicación en el suelo. Poste de fundición de aluminio primario; elevada resistencia a la oxidación gracias al tratamiento de pasivación a base de circonio y pintura en polvo a base de resinas de poliéster, UV estabilizada. Tornillería incluida.

BORDO MARE: añada S al final del código seleccionado incluyendo el color LED para que el producto se suministre con tratamiento marino contra la niebla salina.

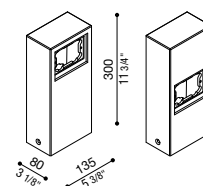

Dima e kit di fissaggio Palo Stile Next

Dima, tirafondi e minuteria per ancoraggio del palo al terreno.

Template and fixing kit for post Stile Next

Template, fixing bolts and small metal parts to secure the post to the ground.

Gabarit, tire-fond et visserie pour ancrage du poteau Stile Next

Gabarit, tire-fond et visserie pour ancrage du poteau au sol.

Plantilla y kit de fijación Poste Stile Next

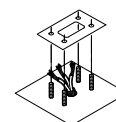

Plantilla, tirafondos y tornillería para el anclaje del poste al suelo.

Col.	Code
	LB11255



Box Alluminio 503

Box per montaggio sporgente a parete (non per incasso).
Corpo in alluminio primario pressofuso EN-AB44100; elevata resistenza all'ossidazione grazie al trattamento di passivazione a base di zirconio e alla verniciatura con resine poliestere stabilizzata ai raggi UV.

CoL.	Code
	LB11841
	LB1184G

Box in aluminium 503

Box for surface wall mounting (not recessed).
 Body made of EN-AB44100 die-cast aluminium primary alloy; highly resistant to oxidization thanks to the zirconium-based passivation treatment and UV stabilized polyester resin coating.

Box aluminium 503

Box pour le montage au mur en saillie (pas à encastrement).
 Corps en aluminium primaire injecté EN-AB44100; haute résistance à l'oxydation grâce au traitement de passivation à base de zirconium et laquage poudre à base de résines polyesters, fixées au rayon UV.

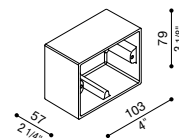

Box aluminio 503

Caja para montaje saliente de pared (no para empotrar).
 Cuerpo de fundición de aluminio primario EN-AB44100; elevada resistencia a la oxidación gracias al tratamiento de pasivación a base de circonio y pintura en polvo a base de resinas de poliéster, UV estabilizada.



Box Alluminio 506E

Box per montaggio sporgente a parete (non per incasso).
Corpo in alluminio primario pressofuso EN-AB44100; elevata resistenza all'ossidazione grazie al trattamento di passivazione a base di zirconio e alla verniciatura con resine poliestere stabilizzata ai raggi UV.

CoL.	Code
	LB11611
	LB1161G

Box in aluminium 506E

Box for surface wall mounting (not recessed).
 Body made of EN-AB44100 die-cast aluminium primary alloy; highly resistant to oxidization thanks to the zirconium-based passivation treatment and UV stabilized polyester resin coating.

Box Aluminium 506E

Box pour le montage au mur en saillie (pas à encastrement).
 Corps en aluminium primaire injecté EN-AB44100; haute résistance à l'oxydation grâce au traitement de passivation à base de zirconium et laquage poudre à base de résines polyesters, fixées au rayon UV.

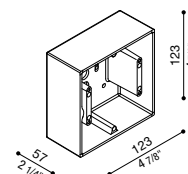

Box aluminio 506E

Caja para montaje saliente de pared (no para empotrar).
 Cuerpo de fundición de aluminio primario EN-AB44100; elevada resistencia a la oxidación gracias al tratamiento de pasivación a base de circonio y pintura en polvo a base de resinas de poliéster, UV estabilizada.



Box Alluminio 506L

Box per montaggio sporgente a parete (non per incasso).
Corpo in alluminio primario pressofuso EN-AB44100; elevata resistenza all'ossidazione grazie al trattamento di passivazione a base di zirconio e alla verniciatura con resine poliestere stabilizzata ai raggi UV.

CoL.	Code
	LB11621
	LB1162G

Box in aluminium 506L

Box for surface wall mounting (not recessed).
 Body made of EN-AB44100 die-cast aluminium primary alloy; highly resistant to oxidization thanks to the zirconium-based passivation treatment and UV stabilized polyester resin coating.

Box Aluminium 506L

Box pour le montage au mur en saillie (pas à encastrement).
 Corps en aluminium primaire injecté EN-AB44100; haute résistance à l'oxydation grâce au traitement de passivation à base de zirconium et laquage poudre à base de résines polyesters, fixées au rayon UV.

Box aluminio 506L

Caja para montaje saliente de pared (no para empotrar).
 Cuerpo de fundición de aluminio primario EN-AB44100; elevada resistencia a la oxidación gracias al tratamiento de pasivación a base de circonio y pintura en polvo a base de resinas de poliéster, UV estabilizada.

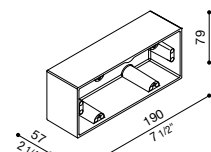

Scatola Incasso Standard 503

Recess Box 503

CoL. Code

Armature à encastrer standard 503

LB11660

Caja de empotrar standard 503

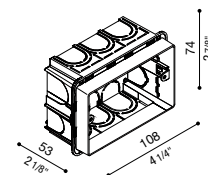

Scatola Incasso Standard 506L

Recess Box 506L

CoL. Code

Armature à encastrer standard 506L

LB11680

Caja de empotrar standard 506L

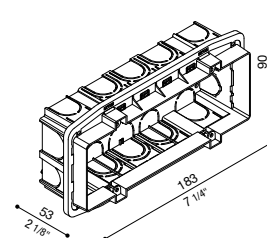

Scatola Incasso Standard 506E

Recess Box 506E

CoL. Code

Armature à encastrer standard 506E

LB11670

Caja de empotrar standard 506E

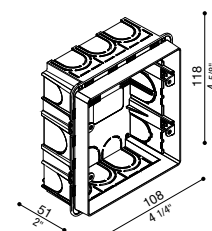



FEATURES



Ancora un passo avanti

Per l'installazione a terra Stile Next dispone di un robusto paletto in tecnopolimero, nero o verniciato in grigio high tech. Predisposto per alloggiare il modello Stile Next 506-L su un lato e integrabile sull'altro con Stile Next 503 consentendo nuovi utilizzi grazie alla doppia illuminazione; inoltre è predisposto per accogliere anche un coperchio per presa elettrica della Bticino mod. IDROBOX LUNA IP55 - Cod. 24602L.

Another step forward

For ground mounted column installation, Stile Next can offer a sturdy technopolymer post in black or coated in high tech grey. Designed to hold model Stile Next 506-L on one side, and optionally with Stile Next 503 on the other, it can also, be used for new purposes thanks to the dual lighting possibility. Furthermore, it has also been designed to accommodate an IP rated electric socket manufactured by Bticino mod. IDROBOX LUNA IP55 - Code 24602L.

Encore un pas en avant

Pour l'installation au sol Stile Next dispose d'un robuste poteau en technopolymère, noir ou laqué de couleur gris High Tech. Conçu pour loger d'un côté le modèle Stile Next 506-L et de l'autre côté pour intégrer le modèle Stile Next 503; il réalise ainsi de nouvelles utilisations grâce au double éclairage; il a été également conçu pour l'application d'un couvercle de la prise de courant Bticino mod. IDROBOX LUNA IP55 - Cod. 24602L.

Un paso más allá

Para la instalación en el suelo, Stile Next dispone de un robusto poste de tecnopolímero, negro o pintado en gris HT. Preparado para alojar Stile Next 506-L por un lado y puede integrarse por el otro con Stile Next 503 permitiendo nuevos usos gracias a la doble iluminación; también está diseñado para alojar una tapa para toma eléctrica biticino mod. IDROBOX LUNA IP55 - Código 24602L.



Disponibile anche con finitura "CORTEN".

Available with CORTEN finish.

Finition CORTEN disponible.

También disponible en acabado corten.



Fronte | Front | Devant | Frente

Retro | Back | Derrière | Atrás

Il paletto è provvisto di coperchi amovibili, che vanno asportati nel caso si applichino gli apparecchi (non inclusi).

The post is provided with removable covers which can be removed to accommodate the luminaires (to be ordered separately).

Le poteau est muni de couvercles amovibles que l'on peut retirer quand on applique les appareils (non inclus).

El poste está provisto de tapas desmontables, que deben retirarse en caso de que se instalen luminarias (no incluidas).

STILE NEXT 103/503 ASIMMETRICA



STILE NEXT

Installazione

Installation
Installation
Instalación

Incasso parete

Wall recess
Encastrement au mur
Empotrar pared

Materiali

Materials
Materiali
Materiales

Materiale Corpo: Alluminio | Tipo di diffusore: Vetro serigrafato

Material: Aluminium | Diffuser type: Serigraphed glass
Matériel du corps: Aluminium | Type de diffuseur: Verre sérigraphié
Material del cuerpo: Aluminio | Tipo de difusor: Vidro serigrafiado

Alimentazione

Power supply
Alimentation
Alimentación

220-240 V - 24V



STILE NEXT
103



STILE NEXT
103 ASIMMETRICO



STILE NEXT
106L



STILE NEXT
106L ASIMMETRICO



STILE NEXT
106L ASIMMETRICO
ORIZZONTALE



STILE NEXT
106E

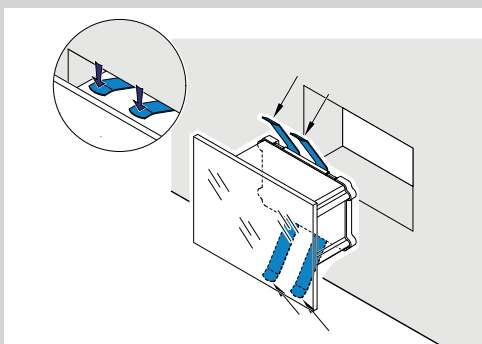

Incasso a muro ed in cartongesso senza l'utilizzo di scatola.

Recessed in wall and plasterboard without any box.

Encastrement dans le mur et dans le placoplâtre sans utilisation de boîte.

Empotrado en pared y falso techo sin caja.

COLOURS



Neutral





Stile Next 103

IP66 IK 06 1J xx3 CE UK CA	LED			COL.	CODE *	
	W	LM	REAL LM			
	3	310	68	  220-240 V	 LL642C	
	6	720	170	  220-240 V	 LL642D	

* Complete the CODE LED COLOUR N | 4000K 3 | 3000K

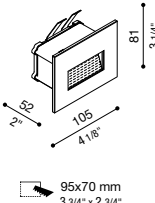
Predisposto per singolo ingresso alimentazione. | Single cable entry at the back. | Entrée d'alimentation simple. | Preparado para la entrada de una única alimentación.

Stile Next 103 Asimmetrica

IP66 IK 06 1J xx3 CE UK CA	LED			COL.	CODE *	
	W	LM	REAL LM			
	3	310	45	  220-240 V	 LL644C	

* Complete the CODE LED COLOUR N | 4000K 3 | 3000K

Predisposto per singolo ingresso alimentazione. Deflettore in alluminio primario pressofuso EN-AB44100. | Single cable entry at the back. Reflector made of EN-AB44100 die-cast aluminium primary alloy. | Entrée d'alimentation simple. Réflecteur en aluminium primaire injecté EN-AB44100 | Preparado para la entrada de una única alimentación. Reflector de fundición de aluminio primario EN-AB44100.

Stile Next 106L

IP66 IK 06 1J xx3 CE UK CA	LED			COL.	CODE *	
	W	LM	REAL LM			
	6	720	217	  220-240 V	 LL662D	
	6	720	217	  24V	 LL663D	

* Complete the CODE LED COLOUR N | 4000K 3 | 3000K

Predisposto per doppio ingresso alimentazione. LL663DN/3 alimentatore escluso. | Double cable entry at the back. LL663DN/3 ballast not included. | Possibilité alimentation double entrée. LL663DN/3 ballast exclus. | Preparado para doble entrada de alimentación. LL663DN/3 Alimentador no incluido.

Stile Next 106L Asimmetrica

IP66 IK 06 1J xx3 CE UK EBA	LED			COL.	CODE *
	W	LM	REAL LM		
	3	310	38	 220-240 V	 LL664C□



172x68 mm
6 3/4" x 2 5/8"

* Complete the CODE LED COLOUR N | 4000K 3 | 3000K

Predisposto per doppio ingresso alimentazione. Deflettore in alluminio primario pressofuso EN-AB44100. | Double cable entries at the back. Reflector made of EN-AB44100 die-cast aluminium primary alloy. | Possibilità alimentazione double entrée. Réflecteur en aluminium primaire injecté EN-AB44100. | Preparado para doble entrada de alimentación. Reflector de fundición de aluminio primario EN-AB44100.

Stile Next 106L Asimmetrica Orizzontale

IP66 IK 06 1J xx3 CE UK EBA	LED			COL.	CODE *
	W	LM	REAL LM		
	4	490	70	 220-240 V	 LL666F□







172x68 mm
6 3/4" x 2 5/8"

* Complete the CODE LED COLOUR N | 4000K 3 | 3000K

Predisposto per doppio ingresso alimentazione. Deflettore in alluminio primario pressofuso EN-AB44100. | Double cable entry at the back. Reflector made of EN-AB44100 die-cast aluminium primary alloy. | Possibilità alimentazione double entrée. Réflecteur en aluminium primaire injecté EN-AB44100. | Preparado para doble entrada de alimentación. Reflector de fundición de aluminio primario EN-AB44100.

Stile Next 106E

IP66 IK 06 1J xx3 CE UK EBA	LED			COL.	CODE *
	W	LM	REAL LM		
	6	720	283	 220-240 V	 LL652D□
	6	720	283	 24V	 LL653D□

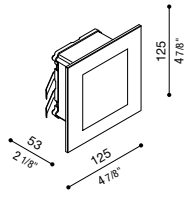

105x105 mm
4 1/8" x 4 1/8"

* Complete the CODE LED COLOUR N | 4000K 3 | 3000K

Predisposto per doppio ingresso alimentazione. LL653DN/3 alimentatore escluso. | Double cable entry at the back. LL653DN/3 ballast not included. | Possibilità alimentazione double entrée. LL653DN/3 ballast exclus. | Preparado para doble entrada de alimentación. LL653DN/3 Alimentador no incluido.

Cemento Style 103

FINO A ESAURIMENTO SCORTE

Apparecchio non incluso. Struttura in cemento per installazione a pavimento relativa bulloneria.

Peso dell'accessorio in cemento con prodotto inserito: 2.7kg.

Prodotti associati: Stile Next 103 - Stile Next 103 Asimmetrica.

Cemento Style 103

Lighting fixture not included. Body made of concrete for ground application. Fixing nuts and bolts included.

Total weight of the concrete post with product fitted inside: 2.7Kg/5.95Lb.

Suitable for fitting with our Stile Next 103; Stile Next 103 Asimmetrica.

Cemento Style 103

Appareil non inclus. Structure en ciment pour installation au sol avec visserie (fixation).

Poids brut du support avec bâti inclus: 2.7Kg/5.95Lb.

Produits complémentaires: Stile Next 103 - Stile Next 103 Asimmetrica.

Cemento Style 103

Lámpara no incluida. Estructura de cemento para instalación en el suelo con diferentes colores, y pernos de acero inoxidable A4.

Peso del accesorio de concreto con producto incluido: 2.7Kg/5.95Lb.

Productos asociados: Stile Next 103 - Stile Next 103 Asimmetrica.

Col.	Code
------	------



LB11854

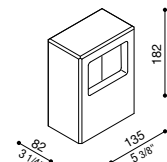

Cassaforma Polistirolo Stile Next 103

Cassaforma in polistirolo.

Polystyrene mould Stile Next 503

Polystyrene mould.

Gabarit en polystyrène Stile Next 103

Gabarit en polystyrène.

Encofrado de poliestireno Stile Next 103

Encofrado de poliestireno.

Col.	Code
------	------

LB11571

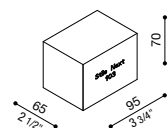

Cassaforma Polistirolo Stile Next 106L

Cassaforma in polistirolo.

Polystyrene mould Stile Next 106L

Polystyrene mould.

Gabarit en polystyrène Stile Next 106L

Gabarit en polystyrène.

Encofrado de poliestireno Stile Next 106L

Encofrado de poliestireno.

Col.	Code
------	------

LB11573

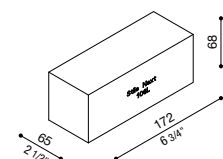

Cassaforma Polistirolo Stile Next 106E

Cassaforma in polistirolo.

Polystyrene mould Stile Next 106E

Polystyrene mould.

Gabarit en polystyrène Stile Next 106E

Gabarit en polystyrène.

Encofrado de poliestireno Stile Next 106E

Encofrado de poliestireno.

Col.	Code
------	------

LB11572

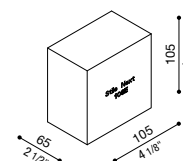

STILE NEXT 103/503 ASIMMETRICA



STILE NEXT 103/503 - STILE NEXT 506L/106L



STILE NEXT 260

Installazione

Installation
Installation
Instalación

Incasso parete

Wall recess
Encastrament au mur
Empotrar pared

Materiali

Materials
Materiali
Materiales

Materiale Corpo: Alluminio | Tipo di diffusore: Vetro serigrafato

Material: Aluminium | Diffuser type: Serigraphed glass
Matériel du corps: Aluminium | Type de diffuseur: Verre sérigraphié
Material del cuerpo: Aluminio | Tipo de difusor: Vidro serigrafiado

Alimentazione

Power supply
Alimentation
Alimentación

220-240 V - lampadina E27 (non inclusa)

220-240 V - E27 light bulb (not included)
220-240 V - ampoule E27 (pas inclus)
220-240 V - bombilla E27 (no incluida)



STILE NEXT 260



COLOURS



Neutral

Stile Next 260

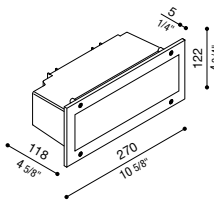
IP66 IK 06 1J xx3 CE UK EA	LED			COL.	CODE *	
	W	LM	REAL LM			
	10	1300	386	⊕ ⊙ 220-240 V	LL785E□	
	LAMP					
	ATT. MAX	CFL				
	E27	1x20	⊕	LB7852N		

* Complete the CODE □ LED COLOUR N | 4000K 3 | 3000K

Lampade dim. max: E27 145 mm Ø 48 mm. | Lamp dim. max: E27 145 mm Ø 48 mm. | Lampes dim. max: E27 145 mm Ø 48 mm. | Dim. máx. lámparas: E27 145 mm. Ø 48 mm.

Accessori | Accessories | Accessoires | Accesorios

Armatura da incasso Stile 260 - Stile Next 260

Armatura da incasso in termoplastico.

Thermoplastic recess box Stile 260 - Stile Next 260
Thermoplastic recess box.

Col.	Code
	LB11530

Armature à encastrer Stile 260 / Stile Next 260
Armature à encastrer en matériau thermoplastique.

Caja de empotrar Stile 260 / Stile Next 260
Caja de empotrar de material termoplástico.

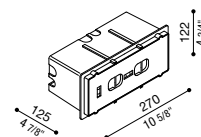

Cassaforma Polistirolo Stile 260 - Stile Next 260

Cassaforma in polistirolo.

Polystyrene mould Stile 260 - Stile Next 260
Polystyrene mould.

Col.	Code
	LB11550

Gabarit en polystyrène Stile 260 / Stile Next 260
Gabarit en polystyrène.

Encofrado de poliestireno Stile 260 / Stile Next 260
Encofrado de poliestireno.

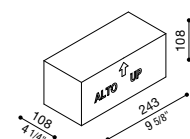

Morsettiera coassiale 3 poli

Morsettiera coassiale a 3 poli, IP68, per cavo ø 7/12 mm.

3-pole coaxial terminal block
3-pole coaxial terminal block, IP68, for cable ø 7/12 mm.

Bornier coaxial à 3 pôles
Bornier coaxial à 3 pôles, IP68, pour câble ø 7/12 mm.

Bloque de terminales coaxiales de 3 polos
Bloque de terminales coaxiales de 3 polos, IP68, para cable ø 7/12 mm.

Col.	Code
	LB11293

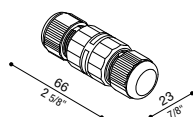

Morsettiera lineare a 3 vie

Morsettiera lineare a 3 vie a 3 poli, IP68, per cavo ø 7/13,5 mm.

3 way linear terminal block
3-way 3-pole linear terminal block, IP68, for cable Ø 7/13.5 mm.

Bornier linéaire 3 voies
Bornier linéaire 3 voies à 3 pôles, IP68, pour câble diam. 7/13,5 mm

Caja de bornes lineal de 3 vías
Caja de bornes lineal de 3 vías y de 3 polos, IP68, para cable con ø 7/13,5 mm.

Col.	Code
	LB11294

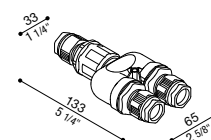

KIT STILE NEXT POST

Installazione

Installation
Installation
Instalación

Terra

Ground
Sol
Suelo

Materiali

Materials
Materiali
Materiales

Materiale Corpo: Stile Next in Alluminio e Palo in Tecnopolimero - Alluminio | Tipo di diffusore: Vetro serigrafato

Material: Stile Next Aluminium and Post Technopolymer - Aluminium | Diffuser type: Serigraphed glass
Matériel du corps: Stile Next en Aluminium et Poteau en Tecnopolimero - Aluminium | Type de diffuseur: Verre sérigraphié
Material del cuerpo: Stile Next de Aluminio y Poste de Tecnopolimero - Aluminio | Tipo de difusor: Vidro serigrafiado

Alimentazione

Power supply
Alimentation
Alimentación

220-240 V



KIT 01
STILE NEXT POST

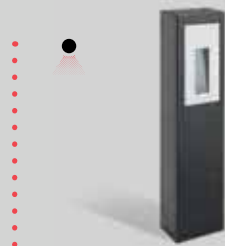

KIT 02
STILE NEXT POST

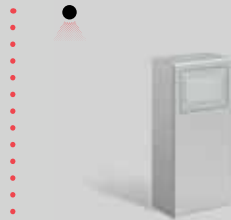

KIT 05
STILE NEXT POST



KIT 06
STILE NEXT POST

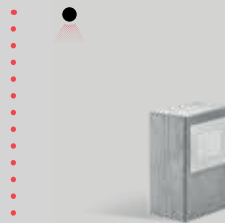

KIT 11
STILE NEXT POST

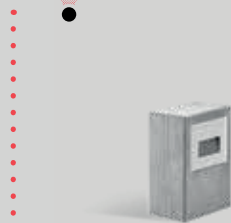

KIT 12
STILE NEXT POST



COLOURS



Grey High Tech RAL 9006



Black



Concrete



Grey anthracite RAL 7021



Corten

Kit 01 - Stile Next Post

IP66 IK 06 1J xx3 CE UK CA	LED			COL.	CODE *	
	W	LM	REAL LM			
	6	720	283		220-240 V	LL661001□
						LL661005□
						LL661009□

* Complete the CODE LED COLOUR N | 4000K 3 | 3000K

Kit composto dagli attuali codici LB11652/G/K + LL661DN/3. | Kit consisting of the current codes LB11652/G/K + LL661DN/3. | Kit composé des codes actuels LB11652/G/K + LL661DN/3. | Kit compuesto por los actuales códigos LB11652/G/K + LL661DN/3.

Kit 02 - Stile Next Post

IP66 IK 06 1J xx3 CE UK CA	LED			COL.	CODE *	
	W	LM	REAL LM			
	3	310	38		220-240 V	LL661002□
						LL661006□
						LL661010□

* Complete the CODE LED COLOUR N | 4000K 3 | 3000K

Kit composto dagli attuali codici LB11652/G/K + LL663CN/3. | Kit consisting of the current codes LB11652/G/K + LL663CN/3. | Kit composé des codes actuels LB11652/G/K + LL663CN/3. | Kit compuesto por los actuales códigos LB11652/G/K + LL663CN/3.





Kit 05 - Stile Next Post

IP66 IK 06 1J xx3 CE UK CA	LED			COL.	CODE *	
	W	LM	REAL LM			
	3	310	68		220-240 V	LL110000□
						LL110012□
						LL110006□
	6	720	170		220-240 V	LL110018□
						LL110019□
						LL110020□

* Complete the CODE LED COLOUR N | 4000K 3 | 3000K

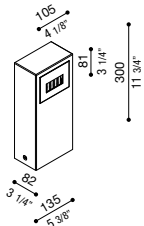
Kit composto dagli attuali codici LB1100000/1/2 + LL641CN/3. BORDO MARE: aggiungi S alla fine del codice selezionato comprensivo di colore LED per avere il prodotto fornito con trattamento bordo mare contro le nebbie saline. | Kit consisting of the current codes LB1100000/1/2 + LL641CN/3. BORDO MARE: add S to the end of the selected code including LED colour to have the product supplied with sea treatment against salt spray. | Kit composé des codes actuels LB1100000/1/2 + LL641CN/3. BORDO MARE: ajoutez S à la fin du code sélectionné, y compris la couleur LED, pour que le produit soit fourni avec un traitement de bord de mer contre le brouillard salin. | Kit compuesto por los actuales códigos LB1100000/1/2 + LL641CN/3. BORDO MARE: añada S al final del código seleccionado incluyendo el color LED para que el producto se suministre con tratamiento marino contra la niebla salina.





Kit 06 - Stile Next Post

IP66 IK 06 1J xx3 CE UK CA	LED			COL.	CODE *	
	W	LM	REAL LM			
	3	310	45		LL110001□ LL110013□ LL110007□	
				220-240 V		

* Complete the CODE □ LED COLOUR N | 4000K 3 | 3000K

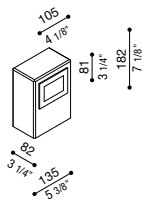
Kit composto dagli attuali codici LB1100000/1/2 + LL643CN/3. BORDO MARE: aggiungi S alla fine del codice selezionato comprensivo di colore LED per avere il prodotto fornito con trattamento bordo mare contro le nebbie saline. | Kit consisting of the current codes LB1100000/1/2 + LL643CN/3. BORDO MARE: add S to the end of the selected code including LED colour to have the product supplied with sea treatment against salt spray. | Kit composé des codes actuels LB1100000/1/2 + LL643CN/3. BORDO MARE: ajoutez S à la fin du code sélectionné, y compris la couleur LED, pour que le produit soit fourni avec un traitement de bord de mer contre le brouillard salin. | Kit compuesto por los actuales códigos LB1100000/1/2 + LL643CN/3. BORDO MARE: añade S al final del código seleccionado incluyendo el color LED para que el producto se suministre con tratamiento marino contra la niebla salina.





Kit 11 - Stile Next Post

IP66 IK 06 1J xx3 CE UK CA	LED			COL.	CODE *	
	W	LM	REAL LM			
	3	310	68		LL642C854□	
				220-240 V		

* Complete the CODE □ LED COLOUR N | 4000K 3 | 3000K

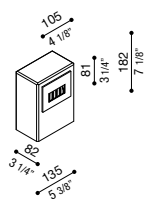
Fino ad esaurimento scorte. Kit composto dagli attuali codici LB11854 + LL642CN/3. | Kit consisting of the current codes LB11854 + LL642CN/3. | Kit composé des codes actuels LB11854 + LL642CN/3. | Kit compuesto por los actuales códigos LB11854 + LL642CN/3.

Kit 12 - Stile Next Post

IP66 IK 06 1J xx3 CE UK CA	LED			COL.	CODE *	
	W	LM	REAL LM			
	3	310	45		LL644C854□	
				220-240 V		

* Complete the CODE □ LED COLOUR N | 4000K 3 | 3000K

Fino ad esaurimento scorte. Kit composto dagli attuali codici LB11854 + LL644CN/3. | Kit consisting of the current codes LB11854 + LL644CN/3. | Kit composé des codes actuels LB11854 + LL644CN/3. | Kit compuesto por los actuales códigos LB11854 + LL644CN/3.

Accessori | Accessories | Accessoires | Accesorios

Dima e kit di fissaggio Palo Stile Next

Dima, tirafondí e minuteria per ancoraggio del palo al terreno.

Template and fixing kit for post Stile Next

Template, fixing bolts and small metal parts to secure the post to the ground.

Gabarit, tire-fond et visserie pour ancrage du poteau Stile Next

Gabarit, tire-fond et visserie pour ancrage du poteau au sol.

Plantilla y kit de fijación Poste Stile Next

Plantilla, tirafondos y tornillería para el anclaje del poste al suelo.

Col.	Code
	LB11255

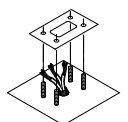

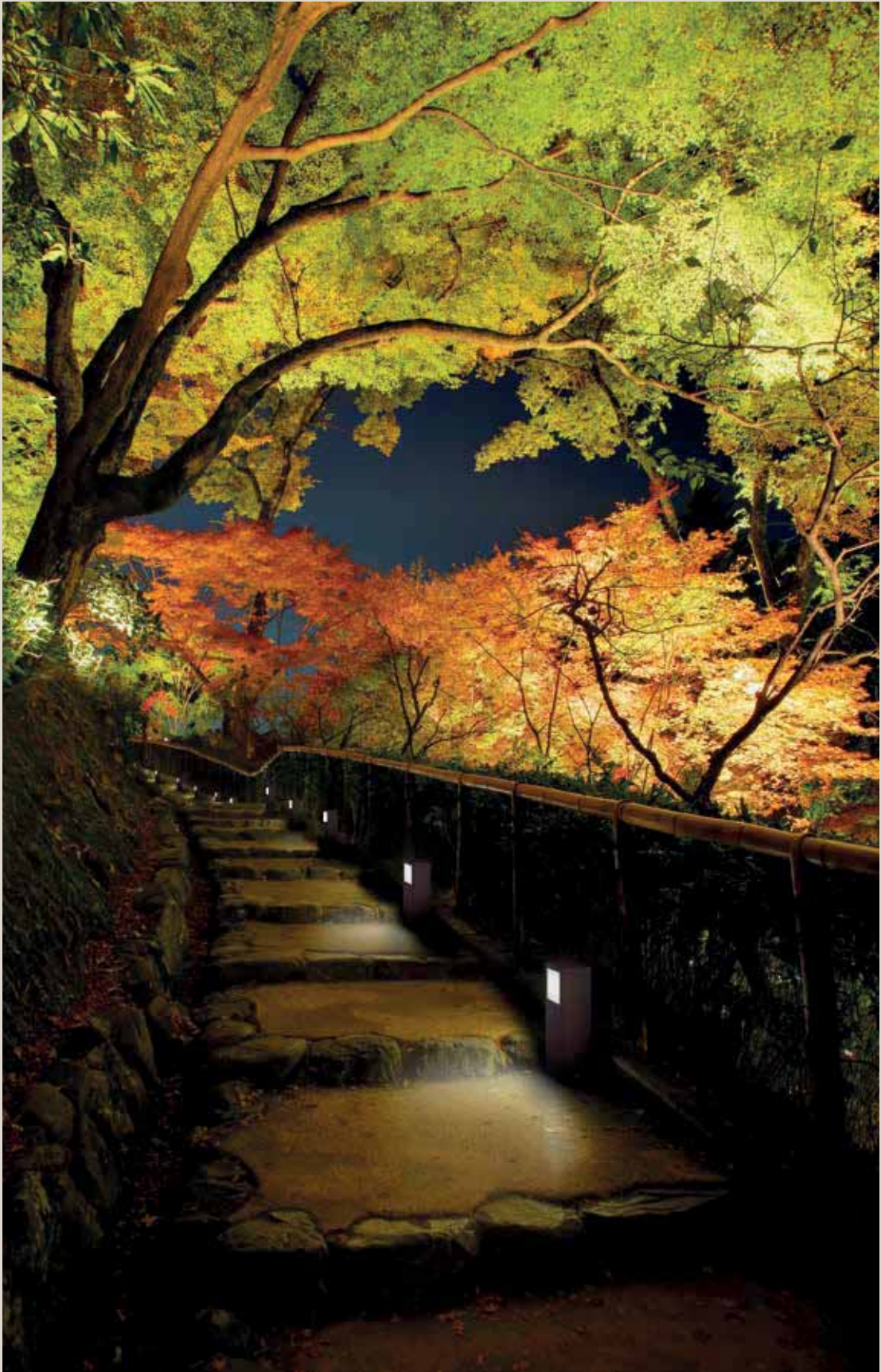

KIT STILE NEXT POST