

Portello e morsetti per Zenit conico

PB00002B

Lombardo.

Generalità

Produttore:
Codice Articolo:
Pezzi per confezione:

Lombardo S.r.l.
PB00002B

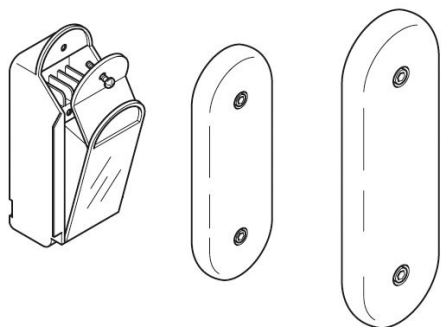

Caratteristiche

Prodotti associati:

Time 180 Midnight Function, Time 180 Soft Midnight Function, Time 360 Midnight Function, Time 360 Soft Midnight Function, Kai 1, Kai 2, Kai 2 D4i, Kai 2 Midnight Function, Time 180, Time 180 Soft, Time 360, Time 360 soft, Versus 3, Versus 4, Versus 2, Versus 1, Delta 3 Asimmetrico, Delta 3 Arc, Delta 2 Simmetrico, Delta 1 Circular, Delta 3 Simmetrico, Delta 3 Circular, Delta 2 Asimmetrico, Delta 1 Simmetrico, Delta 2 Asimmetrico, Delta 1 Arc, Delta 0 Simmetrico, Delta 0 Asimmetrico, Delta 0 Arc, Delta 2 Arc

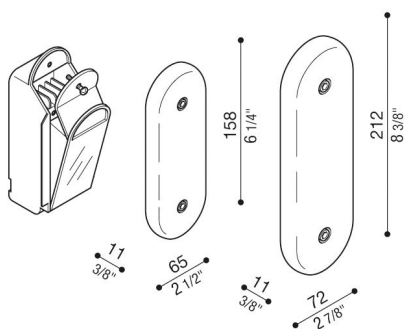

Marchi di Conformità:

CE UK
EA