

CNC OVAL

NEW

The range



CNC OVAL



**CNC OVAL
SUPERFICIE**



**CNC OVAL
GARDEN 40**



**CNC OVAL
GARDEN 100**



**CNC OVAL
POST 40**



**CNC OVAL
POST 100**

CNC 2.0 TRIMLESS



The range



**CNC 35 2.0
TRIMLESS**

pag. 262



**CNC 35 2.0
TRIMLESS
ASIMMETRICO**

pag. 262















**CNC 50 2.0
TRIMLESS**

pag. 262



**CNC 50 2.0
TRIMLESS
ASIMMETRICO**

pag. 262

Caratteristiche Characteristics Caractéristiques Caraterísticas	 47°C	 47°C	 47°C	 47°C
Emissione Emission Émission Emisión				
Colore della luce LED colour Couleur du LED Color LED	N 4000K 3 3000K 2 2700K 1 2200K	N 4000K 3 3000K 2 2700K 1 2200K	N 4000K 3 3000K 2 2700K 1 2200K	N 4000K 3 3000K 2 2700K 1 2200K
Inclinazione ottiche Optics Optique Ópticas	S 20° M 30° L 45° D Diff.	S 20° M 30° L 45° D Diff.	S 20° M 30° L 45° D Diff.	S 20° M 30° L 45° D Diff.
Potenza Output Puissance Potencia	2 W 150 LM	2 W 150 LM	6,5 W 294 LM	6,5 W 294 LM
Alimentazione Power supply Alimentation Alimentación	24 V	24 V	24 V	24 V
Forma Shape Forme Forma				

CNC 2.0

The range



CNC 25 2.0

pag.272



CNC 35 2.0

pag.276



CNC 50 2.0

pag.290

Caratteristiche Characteristics Caractéristiques Características	500 KG MAX	500 KG MAX	500 KG MAX
Emissione Emission Émission Emisión			
Colore della luce LED colour Couleur du LED Color LED	N 4000K 3 3000K 2 2700K 1 2200K	N 4000K 3 3000K 2 2700K 1 2200K	N 4000K 3 3000K 2 2700K 1 2200K
Inclinazione ottiche Optics Optique Ópticas	S 30° M 40° D Diff.	S 20° M 30° L 45° D Diff.	S 25° M 30° L 50° D Diff.
Potenza Output Puissance Potencia	2 W 75 - 150 LM	2 W 48 - 150 LM	6,5 W 252 - 694 LM
Alimentazione Power supply Alimentation Alimentación	24V 500mA - 6V	24V 500mA - 6V	24V 500mA - 15V
Forma Shape Forme Forma			

↘ CNC 25 2.0



CNC 25 2.0
T



CNC 25 2.0
T FULL RESIN



CNC 25 2.0
Q



CNC 25 2.0
Q FULL RESIN

↘ CNC 35 2.0



CNC 35 2.0
T



CNC 35 2.0
T FULL RESIN



CNC 35 2.0
Q



CNC 35 2.0
Q FULL RESIN

↘ CNC 35 SWING 2.0



CNC 35 2.0 SWING



CNC 35 2.0 SWING
SUPERFICIE



CNC 35 2.0 SWING
GARDEN 40



CNC 35 2.0 SWING
GARDEN 100



CNC 35 2.0 SWING
POST 40



CNC 35 2.0 SWING
POST 100

↘ CNC 50 2.0



CNC 50 2.0
T



CNC 50 2.0
T FULL RESIN

CNC

The range



CNC 49

pag. 294



CNC 99

pag. 298



CNC 120

pag. 308



CNC 150

pag. 312

Caratteristiche Characteristics Caractéristiques Características	$^{\circ}\text{C } 53^{\circ}$ MAX 500 KG MAX 1000 KG MAX	$^{\circ}\text{C } 53^{\circ}$ MAX 500 KG MAX 2000 KG MAX	$^{\circ}\text{C } 60^{\circ}$ MAX 2000 KG MAX	$^{\circ}\text{C } 58^{\circ}$ MAX 2000 KG MAX
Emissione Emission Émission Emisión				
Colore della luce LED colour Couleur du LED Color LED	N 4000K 3 3000K 2 2700K	N 4000K 3 3000K 2 2700K	N 4000K 3 3000K 2 2700K	N 4000K 3 3000K 2 2700K
Inclinazione ottiche Optics Optique Ópticas	-	-	S spot-25° M 60° A Asymm. D Diff. B Blade	S 12° M 24° L 32°
Potenza Output Puissance Potencia	2 W 240 LM	5 W 470 LM	9 W 1000 LM	20W 2800 LM
Alimentazione Power supply Alimentation Alimentación	24 V	24 V	700 mA - 12V 12/24 V	600 mA - 35V
Forma Shape Forme Forma				



CNC 25*

pag.314



CNC 35*

pag.318













CNC 50*

pag.324

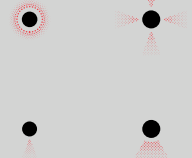
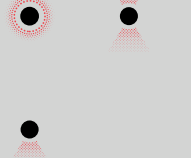

CNC 100*

pag.304

<p>°C 65°^{MAX}  500 KG^{MAX}</p>	<p>°C 65°^{MAX}  500 KG^{MAX}  1000 KG^{MAX}</p>	<p>°C 65°^{MAX}  450 KG^{MAX}  500 KG^{MAX}  2000 KG^{MAX}</p>	<p>°C 50°^{MAX}  280 KG^{MAX}  2000 KG^{MAX}</p>
			
<p>N 4000K 3 3000K 2 2700K B Blue</p>	<p>N 4000K 3 3000K 2 2700K B Blue</p>	<p>N 4000K 3 3000K 2 2700K</p>	<p>N 4000K 3 3000K 2 2700K</p>
<p>S 15° M 30° D Diff.</p>	<p>S 14° M 29° L 46° D Diff.</p>	<p>S 13° M 24° L 53° D Diff.</p>	<p>-</p>
<p>2 W 180 LM</p>	<p>2 W 180 LM</p>	<p>6,5 W 650 LM</p>	<p>3 - 5 W 215 - 430 LM</p>
<p>500 mA - 4.8 V 12/24 V</p>	<p>500 mA - 4.8V 12/24 V</p>	<p>500 mA - 14 V 24 V</p>	<p>700 mA - 3.10 V 700 mA - 6.20V 220 - 240 V</p>
			

* **Fino ad esaurimento.**
 Until our stock lasts.
 Jusqu'à épuisement de stock.
 Hasta el agotamiento del stock.

CNC

The range

↘ CNC 49



CNC 49
CL



CNC 49
C2L



CNC 49
C4L



CNC 49
C180



CNC 49
QL



CNC 49
Q2L



CNC 49
Q4L

↘ CNC 99

Finto incasso.
Surface mounted.
Faux encastré.
Montaje en superficie.



CNC 99
CL



CNC 99
C2L



CNC 99
C4L



CNC 99
C180



CNC 99
C UP



CNC 99
QL



CNC 99
Q2L



CNC 99
Q4L

↘ CNC 120



CNC 120
T

↘ CNC 150



CNC 150

↘ CNC 25*



CNC 25
T



CNC 25
Q

↘ CNC 35*



CNC 35
T



CNC 35
T UP



CNC 35
Q



CNC 35
Q UP



CNC 35
TOP S



CNC 35
TOP L



CNC 35
MASK



CNC 35
SWING



CNC 35
SWING SPOT

↘ CNC 50*



CNC 50
T



CNC 50
T UP



CNC 50
TOP L



CNC 50
TOP 2L



CNC 50
SWING



CNC 50 SWING
SPOT

↘ CNC 100*



CNC 100
L



CNC 100
2L



CNC 100
UP

* Fino ad esaurimento.
Until our stock lasts.
Jusqu'à épuisement de stock.
Hasta el agotamiento del stock.

CNC OVAL NEW

Installazione

Installation
Installation
Instalación

Terra - Parete - Soffitto

Ground - Wall - Ceiling
Sol - Mur - Plafond
Suelo - Pared - Techo

Materiali

Materials
Materiali
Materiales

Materiale Corpo: Alluminio - Acciaio AISI316L | Tipo di diffusore: Vetro

Material: Aluminium - Stainless steel AISI316L | Diffuser type: glass
Matériel du corps: Aluminium - Acier inox AISI316L | Type de diffuseur: Verre
Material del cuerpo: Aluminio - Acero AISI316L | Tipo de difusor: Cristal

Alimentazione

Power supply
Alimentation
Alimentación

24V

Versioni

Versions
Versions
Versiones

Cavo Alimentazione: 1,50 metri H05RN-F 2×0,75 - Honeycomb

Power cable: 1.50 m H05RN-F 2×0.75 - Honeycomb
Câble d'alimentation: 1,50 m H05RN-F 2×0,75 - Honeycomb
Cable de alimentación: 1,50 m H05RN-F 2×0,75 - Honeycomb



CNC OVAL



**CNC OVAL
SUPERFICIE**



**CNC OVAL
GARDEN 40**



**CNC OVAL
GARDEN 100**

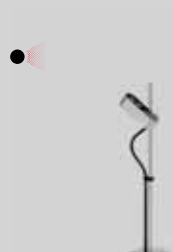

**CNC OVAL
POST 40**



**CNC OVAL
POST 100**



Scopri la gamma
Discover the range
Découvrez la gamme
Descubre la gama

COLOURS



Sandblasted Grey



Grey anthracite RAL 7021



Corten

CNC Oval



IP67 IK 06 1J xx3 CE UK CA	LED			COL.	CODE *
	W	LM	REAL LM		
	4	294	270		LT158400 LT15840E LT15840K
	4	294	130		LT15840H0 LT15840HE LT15840HK

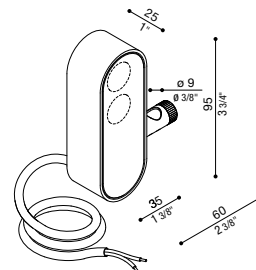

* Complete the CODE ○ OPTIC S | 20° M | 30° L | 45° D | Diff. □ LED COLOUR N | 4000K 3 | 3000K 2 | 2700K 1 | 2200K

Versione Honeycomb non disponibile con ottica D. | Optic D not available for Honeycomb version. | Optique D non disponible pour la version Honeycomb. | La óptica Diff. no está disponible para la versión Honeycomb.

CNC Oval Superficie



IP67 IK 06 1J xx3 CE UK CA	LED			COL.	CODE *
	W	LM	REAL LM		
	4	294	270		LT158410 LT15841E LT15841K
	4	294	130		LT15841H0 LT15841HE LT15841HK

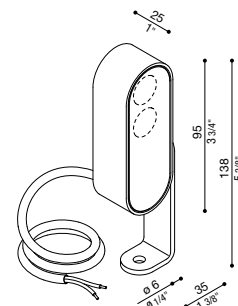

* Complete the CODE ○ OPTIC S | 20° M | 30° L | 45° D | Diff. □ LED COLOUR N | 4000K 3 | 3000K 2 | 2700K 1 | 2200K

Versione Honeycomb non disponibile con ottica D. | Optic D not available for Honeycomb version. | Optique D non disponible pour la version Honeycomb. | La óptica Diff. no está disponible para la versión Honeycomb.

CNC Oval Garden 40



IP67 IK 06 1J xx3 CE UK CA	LED			COL.	CODE *
	W	LM	REAL LM		
	4	294	270		LT158420 LT15842E LT15842K
	4	294	130		LT15842H0 LT15842HE LT15842HK

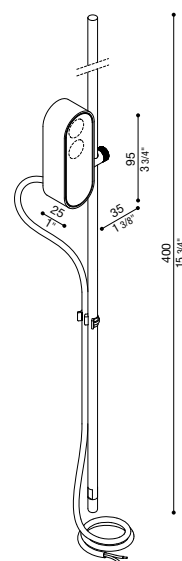







* Complete the CODE ○ OPTIC S | 20° M | 30° L | 45° D | Diff. □ LED COLOUR N | 4000K 3 | 3000K 2 | 2700K 1 | 2200K

Versione Honeycomb non disponibile con ottica D. | Optic D not available for Honeycomb version. | Optique D non disponible pour la version Honeycomb. | La óptica Diff. no está disponible para la versión Honeycomb.

CNC Oval Garden 100



IP67 IK 06 1J xx3 CE UK ER	LED			COL.	CODE *
	W	LM	REAL LM		
	4	294	270		
4	294	130	  24V 	 LT15843H□□  LT15843HE□□  LT15843HK□□	

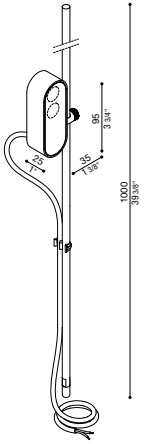







* Complete the CODE ○ OPTIC S | 20° M | 30° L | 45° D | Diff. □ LED COLOUR N | 4000K 3 | 3000K 2 | 2700K 1 | 2200K

Versione Honeycomb non disponibile con ottica D. | Optic D not available for Honeycomb version. | Optique D non disponible pour la version Honeycomb. | La óptica Diff. no está disponible para la versión Honeycomb.

CNC Oval Post 40



IP67 IK 06 1J xx3 CE UK ER	LED			COL.	CODE *
	W	LM	REAL LM		
	4	294	270		
4	294	130	  24V 	 LT15844H□□  LT15844HE□□  LT15844HK□□	

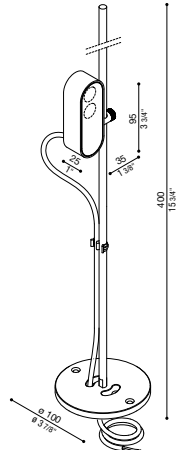







* Complete the CODE ○ OPTIC S | 20° M | 30° L | 45° D | Diff. □ LED COLOUR N | 4000K 3 | 3000K 2 | 2700K 1 | 2200K

Versione Honeycomb non disponibile con ottica D. | Optic D not available for Honeycomb version. | Optique D non disponible pour la version Honeycomb. | La óptica Diff. no está disponible para la versión Honeycomb.

CNC Oval Post 100



IP67 IK 06 1J xx3 CE UK ER	LED			COL.	CODE *
	W	LM	REAL LM		
	4	294	270		
4	294	130	  24V 	 LT15845H□□  LT15845HE□□  LT15845HK□□	

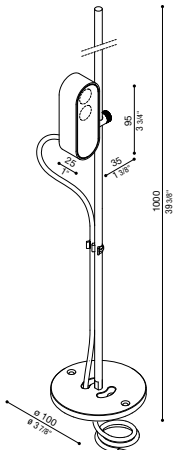

* Complete the CODE ○ OPTIC S | 20° M | 30° L | 45° D | Diff. □ LED COLOUR N | 4000K 3 | 3000K 2 | 2700K 1 | 2200K

Versione Honeycomb non disponibile con ottica D. | Optic D not available for Honeycomb version. | Optique D non disponible pour la version Honeycomb. | La óptica Diff. no está disponible para la versión Honeycomb.

Accessori | Accessories | Accessoires | Accesorios

Cavo H05RN-F 2x0,75

Cavo H05RN-F in Neoprene, sezione 2x0,75. Adatto ad uso esterno.

Cable type H05RN-F 2x0,75

Cable type H05RN-F in Neoprene, section 2x0.75. Suitable for outdoor use.

Câble H05RN-F 2x0,75

Câble H05RN-F en Néoprène, section 2x0,75. Également adapté à l'usage à l'extérieur.

Cable H05RN-F 2x0,75

Cable H05RN-F de Neopreno, sección 2x0,75. Adecuado para el uso al exteriores.

Cavo H05RN-F 5m

CoL.	Code
	LB1070004

Cavo H05RN-F 10m

CoL.	Code
	LB1070005

Cavo H05RN-F 15m

CoL.	Code
	LB1070006

Cavo H05RN-F 20m

CoL.	Code
	LB1070007



Accessorio giardino per CNC

Accessorio da giardino da abbinare a CNC35 Swing / CNC50 Swing / CNC 35 Swing Superficie 2.0, realizzato in metallo zincato a freddo. Adatto per uso esterno. Idoneo per installazione a terra.

Garden accessory - CNC35 - CNC50

Garden accessory for use with CN C35 Swing / CNC50 Swing, made of cold galvanized metal. Suitable for outdoor use and ground application.

Accessoire de jardin - CNC35 - CNC50

Accessoire de jardin à associer à CNC35 Swing / CNC50 Swing, réalisé en métal zingué à froid. Également adapté à l'usage à l'extérieur. Convient pour une utilisation au sol.

Accesorio para jardín - CNC35 - CNC50

Accesorio de jardín a acoplar a CNC35 Swing / CNC50 Swing, realizado en metal galvanizado en frío. Adecuado para el uso al exteriores. Idóneo para instalación en el suelo.

CoL.	Code
	LB1070002

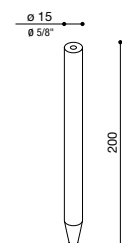

Alimentatori CNC OVAL in tensione costante 12/24V

CNC OVAL ballasts in constant tension 12/24V

Alimentations CNC OVAL en tension 12/24V

Alimentadores CNC OVAL de tensión constante 12/24V

N° max	IP	Code
1/4	20	LB1070029
1/6	67	LB1070031
1/8	20	LB1070030
1/10	67	LB1070032
1/10 0-10V	67	LB1070113
1/20 DALI	67	LB1070114

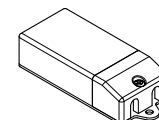

CNC OVAL GARDEN





FEATURES

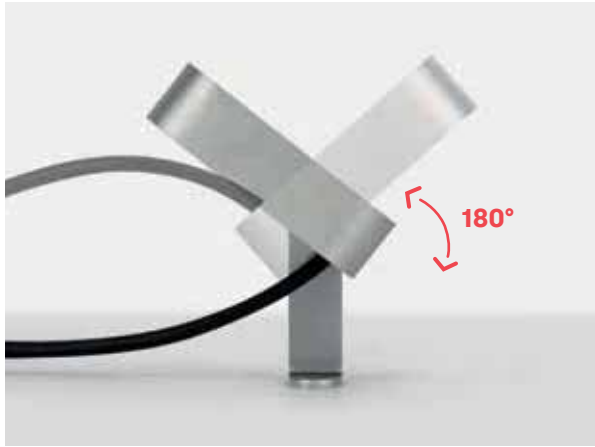

↙ **Rotazione di 180°.**
180° rotation.
Rotation à 180°.
Rotación de 180°.

.....



H40 CM

H100 CM

CNC Oval Post

CNC Oval Garden



FEATURES



Versione standard.
Standard version.
Version Standard.
Versión Standard.

Ottica diffusa.
Diffused optic.
Optique diffuse.
Óptica difusa.



Versione HONEYCOMB.
HONEYCOMB version.
Version HONEYCOMB (nid d'abeille).
Versión HONEYCOMB.



CNC OVAL GARDEN 40



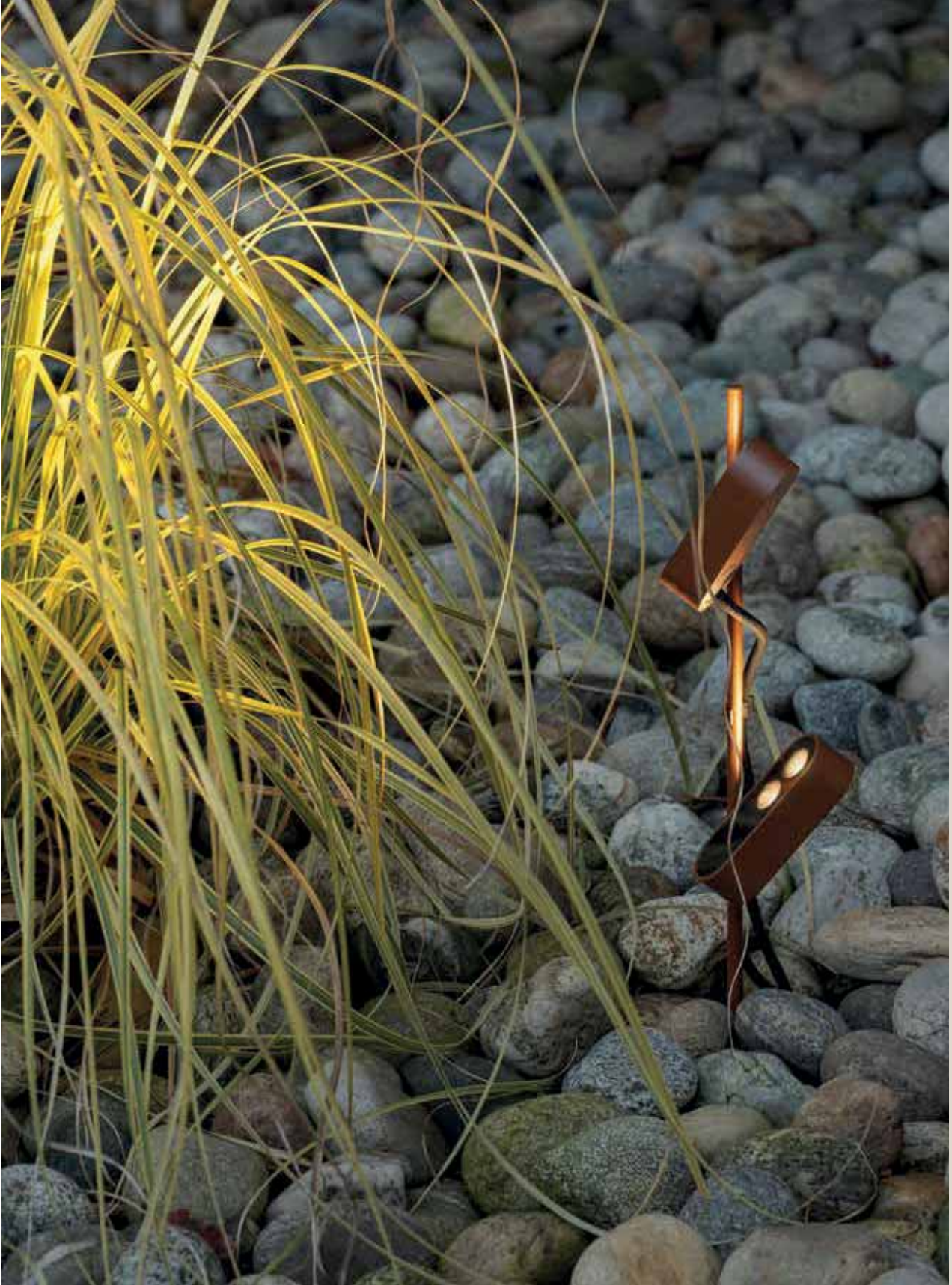

CNC OVAL GARDEN 40

CNC OVAL SUPERFICIE





CNC 2.0 TRIMLESS NEW

Installazione

Installation
Installation
Instalación

Incasso terra

Ground recess
Encastrement au sol
Empotrar suelo

Materiali

Materials
Materiali
Materiales

Materiale Corpo: Alluminio - Acciaio verniciato | Tipo di diffusore: Trasparente | Trattamento: Anodizzazione

Material: Aluminium - Stainless steel | Diffuser type: Transparent | Treatment: Anodization
Matériel du corps: Aluminium - Acier inox | Type de diffuseur: Transparent | Traitement: Anodisation
Material del cuerpo: Aluminio - Acero | Tipo de difusor: Transparente | Tratamiento: Anodización

Alimentazione

Power supply
Alimentation
Alimentación

24V

Versioni

Versions
Versions
Versiones

Cavo Alimentazione: 0,50 metri H05RN-F 2x0,75

Power cable: 0.50 m H05RN-F 2x0.75
Câble d'alimentation: 0,50 m H05RN-F 2x0,75
Cable de alimentación: 0,50 m H05RN-F 2x0,75



CNC 35 2.0 TRIMLESS
T



CNC 35 2.0 TRIMLESS
T ASIMMETRICO



CNC 35 2.0 TRIMLESS
Q



CNC 35 2.0 TRIMLESS
Q ASIMMETRICO



CNC 50 2.0 TRIMLESS
T



CNC 50 2.0 TRIMLESS
T ASIMMETRICO



CNC 50 2.0 TRIMLESS
Q



CNC 50 2.0 TRIMLESS
Q ASIMMETRICO



Scopri la gamma
Discover the range
Découvrez la gamme
Descubre la gama







COLOURS



Neutral

CNC 35 2.0 Trimless T



IP67 IK 09 10J xx7 47°C MAX CE UK CA	LED			COL.	CODE *
	W	LM	REAL LM		
	2	150	140	 ⊗ 24V	 LT15851□□
	2	150	81	 ⊗ 24V 	 LT15851H□□

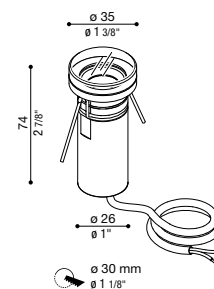





* Complete the CODE OPTIC S | 20° M | 30° L | 45° D | Diff. LED COLOUR N | 4000K 3 | 3000K 2 | 2700K 1 | 2200K

Versione Honeycomb non disponibile con ottica D. | Optic D not available for Honeycomb version. | Optique D non disponible pour la version Honeycomb. | La óptica Diff. no está disponible para la versión Honeycomb.

CNC 35 2.0 Trimless T Asimmetrico



IP67 IK 09 10J xx7 47°C MAX CE UK CA	LED			COL.	CODE *
	W	LM	REAL LM		
	2	150	68	 ⊗ 24V	 LT15855□□
	2	150	40	 ⊗ 24V 	 LT15855H□□

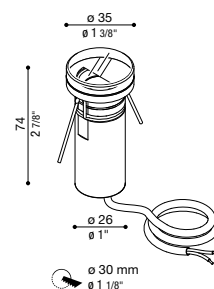







* Complete the CODE OPTIC S | 20° M | 30° L | 45° D | Diff. LED COLOUR N | 4000K 3 | 3000K 2 | 2700K 1 | 2200K

Versione Honeycomb non disponibile con ottica D. | Optic D not available for Honeycomb version. | Optique D non disponible pour la version Honeycomb. | La óptica Diff. no está disponible para la versión Honeycomb.

CNC 35 2.0 Trimless Q



IP67 IK 08 5J xx7 47°C MAX CE UK CA	LED			COL.	CODE *
	W	LM	REAL LM		
	2	150	140	 ⊗ 24V	 LT15852□□
	2	150	81	 ⊗ 24V 	 LT15852H□□

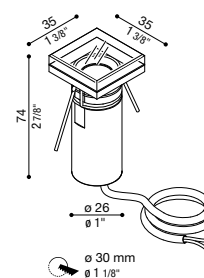







* Complete the CODE OPTIC S | 20° M | 30° L | 45° D | Diff. LED COLOUR N | 4000K 3 | 3000K 2 | 2700K 1 | 2200K

Versione Honeycomb non disponibile con ottica D. | Optic D not available for Honeycomb version. | Optique D non disponible pour la version Honeycomb. | La óptica Diff. no está disponible para la versión Honeycomb.

CNC 35 2.0 Trimless Q Asimmetrico



IP67 IK 08 5J xx7 47°C MAX CE UK CA	LED			COL.	CODE *
	W	LM	REAL LM		
	2	150	68	 ⊗ 24V	 LT15856□□
	2	150	40	 ⊗ 24V 	 LT15856H□□

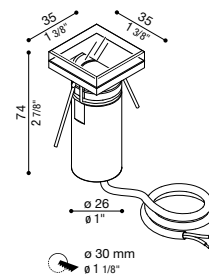







* Complete the CODE ○ OPTIC S | 20° M | 30° L | 45° D | Diff. □ LED COLOUR N | 4000K 3 | 3000K 2 | 2700K 1 | 2200K

Versione Honeycomb non disponibile con ottica D. | Optic D not available for Honeycomb version. | Optique D non disponible pour la version Honeycomb. | La óptica Diff. no está disponible para la versión Honeycomb.

CNC 50 2.0 Trimless T



IP67 IK 09 10J xx7 47°C MAX CE UK CA	LED			COL.	CODE *
	W	LM	REAL LM		
	6,5	694	572	 ⊗ 24V	 LT15853□□
	6,5	694	362	 ⊗ 24V 	 LT15853H□□

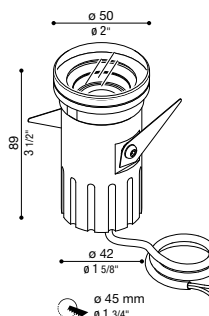







* Complete the CODE ○ OPTIC S | 20° M | 30° L | 45° D | Diff. □ LED COLOUR N | 4000K 3 | 3000K 2 | 2700K 1 | 2200K

Versione Honeycomb non disponibile con ottica D. | Optic D not available for Honeycomb version. | Optique D non disponible pour la version Honeycomb. | La óptica Diff. no está disponible para la versión Honeycomb.

CNC 50 2.0 Trimless T Asimmetrico



IP67 IK 09 10J xx7 47°C MAX CE UK CA	LED			COL.	CODE *
	W	LM	REAL LM		
	6,5	694	280	 ⊗ 24V	 LT15857□□
	6,5	694	131	 ⊗ 24V 	 LT15857H□□

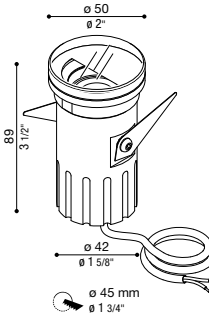

* Complete the CODE ○ OPTIC S | 20° M | 30° L | 45° D | Diff. □ LED COLOUR N | 4000K 3 | 3000K 2 | 2700K 1 | 2200K

Versione Honeycomb non disponibile con ottica D. | Optic D not available for Honeycomb version. | Optique D non disponible pour la version Honeycomb. | La óptica Diff. no está disponible para la versión Honeycomb.

CNC 50 2.0 Trimless Q

NEW

IP67 IK 08 5J xx7 47°C MAX CE UK CA	LED			COL.	CODE *	
	W	LM	REAL LM			
	6,5	694	572	24V	LT15854□□	
	6,5	694	362	24V	LT15854H□□	

* Complete the CODE ○ OPTIC S | 20° M | 30° L | 45° D | Diff. □ LED COLOUR N | 4000K 3 | 3000K 2 | 2700K 1 | 2200K

Versione Honeycomb non disponibile con ottica D. | Optic D not available for Honeycomb version. | Optique D non disponible pour la version Honeycomb. | La óptica Diff. no está disponible para la versión Honeycomb.

CNC 50 2.0 Trimless Q Asimmetrico

NEW

IP67 IK 08 5J xx7 47°C MAX CE UK CA	LED			COL.	CODE *	
	W	LM	REAL LM			
	6,5	694	280	24V	LT15858□□	
	6,5	694	131	24V	LT15858H□□	

* Complete the CODE ○ OPTIC S | 20° M | 30° L | 45° D | Diff. □ LED COLOUR N | 4000K 3 | 3000K 2 | 2700K 1 | 2200K

Versione Honeycomb non disponibile con ottica D. | Optic D not available for Honeycomb version. | Optique D non disponible pour la version Honeycomb. | La óptica Diff. no está disponible para la versión Honeycomb.



Armatura da incasso CNC 35

Armatura da incasso in termoplastico.

Thermoplastic recess box CNC 35

Thermoplastic recess box.

CoL.	Code
	LB1070001

Armature à encastrer CNC 35

Armature à encastrer en matériau thermoplastique.

Caja de empotrar CNC 35

Caja de empotrar de material termoplástico.

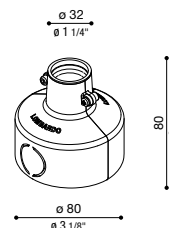

Armatura da incasso CNC 50 2.0 Trimless

Armatura da incasso in termoplastico.

Thermoplastic recess box CNC 50 Trimless

Thermoplastic recess box.

CoL.	Code
	LB1580001

Armature à encastrer CNC 50 Trimless

Armature à encastrer en matériau thermoplastique.

Caja de empotrar CNC 50 Trimless

Caja de empotrar de material termoplástico.

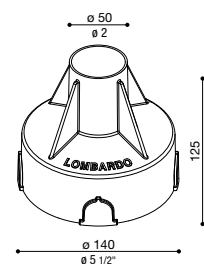

Cavo H05RN-F 2x0,75

Cavo H05RN-F in Neoprene, sezione 2x0,75. Adatto ad uso esterno.

Cable type H05RN-F 2x0,75

Cable type H05RN-F in Neoprene, section 2x0.75. Suitable for outdoor use.

Câble H05RN-F 2x0,75

Câble H05RN-F en Néoprène, section 2x0,75. Également adapté à l'usage à l'extérieur.

Cable H05RN-F 2x0,75

Cable H05RN-F de Neopreno, sección 2x0,75. Adecuado para el uso al exteriores.

Cavo H05RN-F 5m

CoL.	Code
	LB1070004

Cavo H05RN-F 10m

CoL.	Code
	LB1070005

Cavo H05RN-F 15m

CoL.	Code
	LB1070006

Cavo H05RN-F 20m

CoL.	Code
	LB1070007



Alimentatori CNC 35 in tensione costante 12/24V

CNC 35 ballasts in constant tension 12/24V

Alimentations CNC 35 en tension 12/24V

Alimentadores CNC 35 de tensión constante 12/24V

12V			
N° max	IP	Code	
1/6	20	LB1070025	
1/12	20	LB1070026	
1/8	67	LB1070027	
1/15	67	LB1070028	

24V			
N° max	IP	Code	
1/6	20	LB1070029	
1/12	20	LB1070030	
1/8	67	LB1070031	
1/15	67	LB1070032	
1/20 0-10V	67	LB1070113	
1/20 DALI	67	LB1070114	

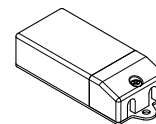

Alimentatori CNC 50 in tensione costante 24V

CNC 50 ballasts in constant tension 24V available

Alimentations CNC 50 en tension 24V

Alimentadores CNC 50 de tensión constante 24V

N° max	IP	Code
1/2	20	LB1070029
1/4	20	LB1070030
1/5	67	LB1070031
1/7	67	LB1070032
1/8 0-10V	67	LB1070113
1/8 DALI	67	LB1070114

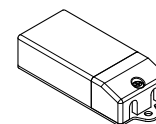



FEATURES

Installazione controcassa a livello pavimento

Installation at floor level
Installation au niveau du sol
Instalación a nivel del suelo



Cementare la controcassa con l'apposito tappo a livello pavimento.
Cement the recessed box with the floor-level cap.
Cimenter la boîte d'encastrement au niveau du sol avec le bouchon approprié.
Cimentar la caja de empotrar a nivel del suelo con el tapón adecuado.



Rimuovere l'apposito tappo.
Remove the cap.
Retirer le bouchon.
Quitar el tapón.



Posizionare il CNC 2.0 Trimless.
Place the CNC 2.0 Trimless.
Positionner CNC 2.0 Trimless.
Instalación del CNC Trimless 2.0.

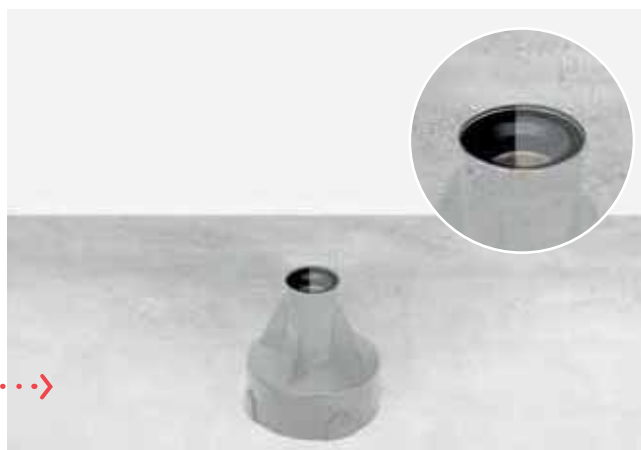

Il prodotto risulterà perfettamente a livello pavimento.
The product will be perfectly levelled with the floor.
Le produit sera parfaitement au niveau du sol.
El producto quedará perfectamente nivelado con el suelo.



Aquastop integrato.
Integrated aquastop.
Aquastop intégré.
Aquastop integrado.



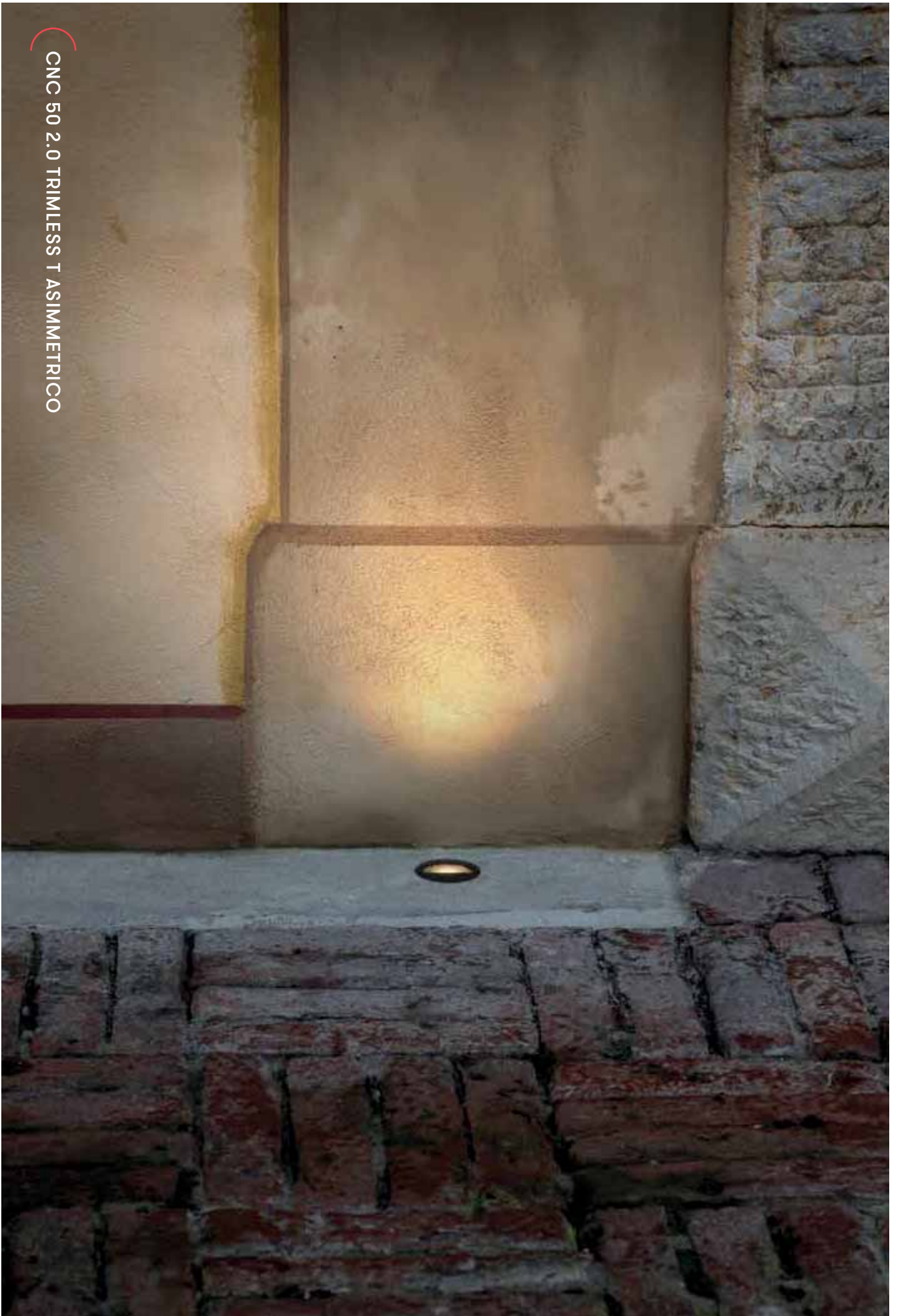

CNC 50 2.0 TRIMLESS T ASIMMETRICO



Versione standard.
Standard version.
Version Standard.
Versión Standard.



Optica D (diffuso).
Optic D (diffused).
Optique D (diffus).
Óptica D (difuso).



Versione HONEYCOMB.
HONEYCOMB version.
Version HONEYCOMB
Versión HONEYCOMB.



CNC 35 2.0 TRIMLESS T



CNC 50 2.0 TRIMLESS Q ASIMMETRICO



CNC 25 2.0

Installazione

Installation
Installation
Instalación

Incasso terra - Incasso parete - Incasso soffitto

Ground recess - Wall recess - Ceiling recess
Encastrement au sol - Encastrement au mur - Encastrement au plafond
Empotrar suelo - Empotrar pared - Empotrar techo

Materiali

Materials
Materiali
Materiales

Materiale Corpo: Alluminio, Acciaio AISI316L | Tipo di diffusore: Vetro | Trattamento: Anodizzazione

Material: Aluminium, Stainless steel AISI316L | Diffuser type: Glass | Treatment: Anodization
Matériel du corps: Aluminium, Acier inox AISI316L | Type de diffuseur: Verre | Traitement: Anodisation
Material del cuerpo: Aluminio, Acero AISI316L | Tipo de difusor: Cristal | Tratamiento: Anodización

Alimentazione

Power supply
Alimentation
Alimentación

24V - 500mA - 6V

Versioni

Versions
Versions
Versiones

Cavo Alimentazione: 0,50 metri H05RN-F 2×0,75

Power cable: 0.50 m H05RN-F 2×0.75
Câble d'alimentation: 0,50 m H05RN-F 2×0,75
Cable de alimentación: 0,50 m H05RN-F 2×0,75



CNC 25 2.0
T



CNC 25 2.0
T FULL RESIN



CNC 25 2.0
Q



CNC 25 2.0
Q FULL RESIN



Scopri la gamma
Discover the range
Découvrez la gamme
Descubre la gama

COLOURS



Sandblasted Grey



Grey anthracite RAL 7021



Corten



White RAL 9010



Black PVD

CNC 25 2.0 T

IP67 IK 10 20J xx9 	LED		W	LM	REAL LM	COL.	CODE *
	2	150	137			24V	LT158000□□ LT15800E□□ LT15800K□□ LT15800W□□ LT15800B□□
	2	150	137			500mA - 6V	LZ158000□□ LZ15800E□□ LZ15800K□□ LZ15800W□□ LZ15800B□□

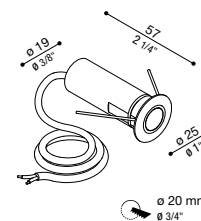

* Complete the CODE OPTIC S | 30° M | 40° D | Diff. LED COLOUR N | 4000K 3 | 3000K 2 | 2700K 1 | 2200K

Versione Honeycomb non disponibile con ottica D. | Optic D not available for Honeycomb version. | Optique D non disponible pour la version Honeycomb. | La óptica Diff. no está disponible para la versión Honeycomb.

CNC 25 2.0 T Full Resin

IP69 / IP 67 IK 10 20J xx9 	LED		W	LM	REAL LM	COL.	CODE *
	2	150	75			24V	LT158000F□□ LT15800EF□□ LT15800KF□□ LT15800WF□□ LT15800BF□□
	2	150	75			500mA - 6V	LZ158000F□□ LZ15800EF□□ LZ15800KF□□ LZ15800WF□□ LZ15800BF□□

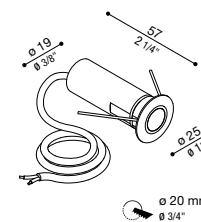

* Complete the CODE LED COLOUR N | 4000K 3 | 3000K 2 | 2700K 1 | 2200K

Versione Full Resin: nuova tecnologia di incapsulamento dei led e circuiti elettronici che allunga la durata del prodotto. Presenta vetro diffuso. | Full Resin version: new LED and circuit encapsulation technology that extends product life. Features diffused glass. | Version Full Resin: nouvelle technologie d'encapsulation des LED et circuit électronique qui prolonge la durée de vie du produit. Comprend un verre diffus. | Versión Full Resin: nueva tecnología de encapsulación de LED y circuitos electrónicos que prolongan la vida útil del producto. Incorpora cristal difuso.

CNC 25 2.0 Q



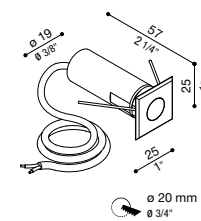











IP67 IK 10 20J xx9 	LED		W	LM	REAL LM	COL.	CODE *
	2	150	137			24V	LT158010□□ LT15801E□□ LT15801K□□ LT15801W□□ LT15801B□□
	2	150	137			500mA - 6V	LZ158010□□ LZ15801E□□ LZ15801K□□ LZ15801W□□ LZ15801B□□



* Complete the CODE OPTIC S | 30° M | 40° D | Diff. LED COLOUR N | 4000K 3 | 3000K 2 | 2700K 1 | 2200K

Versione Honeycomb non disponibile con ottica D. | Optic D not available for Honeycomb version. | Optique D non disponible pour la version Honeycomb. | La óptica Diff. no está disponible para la versión Honeycomb.

CNC 25 2.0 Q Full Resin

IP69 / IP 67 IK 10 20J xx9 500 KG MAX CE UK CR	LED			COL.	CODE *
	W	LM	REAL LM		
 	2	150	75	 24V	 LT158010F□
					 LT15801EF□
					 LT15801KF□
					 LT15801WF□
					 LT15801BF□
	2	150	75	 500mA - 6V	 LZ158010F□
					 LZ15801EF□
					 LZ15801KF□
					 LZ15801WF□
					 LZ15801BF□

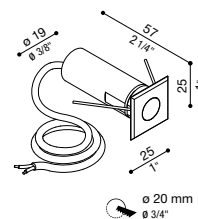

* Complete the CODE □ LED COLOUR N | 4000K 3 | 3000K 2 | 2700K 1 | 2200K

Versione Full Resin: nuova tecnologia di incapsulamento dei led e circuiti elettronici che allunga la durata del prodotto. Presenta vetro diffuso. | Full Resin version: new LED and circuit encapsulation technology that extends product life. Features diffused glass. | Version Full Resin: nouvelle technologie d'encapsulation des LED et circuit électronique qui prolonge la durée de vie du produit. Comprend un verre diffus. | Versión Full Resin: nueva tecnología de encapsulación de LED y circuitos electrónicos que prolongan la vida útil del producto. Incorpora cristal difuso.

Accessori | Accessories | Accessoires | Accesorios

Alimentatori CNC 25 in tensione costante 12/24V

CNC 25 ballasts in constant tension 12/24V	12V			24V		
	N° max	IP	Code	N° max	IP	Code
Alimentations CNC 25 en tension 12/24V	1/6	20	LB1070025	1/6	20	LB1070029
	1/12	20	LB1070026	1/12	20	LB1070030
	1/8	67	LB1070027	1/8	67	LB1070031
Alimentadores CNC 25 de tensión constante 12/24V	1/15	67	LB1070028	1/15	67	LB1070032
				1/20 0-10V	67	LB1070113
				1/20 DALI	67	LB1070114

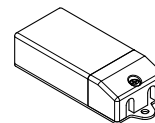

Alimentatori CNC 25 in corrente costante

CNC 25 ballasts in constant current	350mA			500mA		
	N° max	IP	Code	N° max	IP	Code
Alimentations CNC 25 en courant constant	1/2	20	LB1070008	1/2	20	LB1070015
	1/4	20	LB1070009	1/4	20	LB1070016
	5/10	20	LB1070011	5/10	20	LB1070018
Alimentadores CNC 25	1/2 1-10V PUSH	20	LB1070012	1/12 1-10V PUSH	20	LB1070019
	5/10	67	LB1070014	1/4	67	LB1070020
	2/4	67	LB1070013	5/10	67	LB1070021
	2/9 DALI	20	LB1070064	2/9 DALI	20	LB1070064
				1/7 1-10V PUSH	20	LB1070043

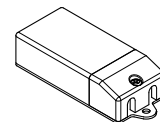

Cavo H05RN-F 2x0,75

Cavo H05RN-F in Neoprene, sezione 2x0,75.
Adatto ad uso esterno.

Cable type H05RN-F 2x0,75

Cable type H05RN-F in Neoprene, section 2x0.75.
Suitable for outdoor use.

Câble H05RN-F 2x0,75

Câble H05RN-F en Néoprène, section 2x0,75.
Également adapté à l'usage à l'extérieur.

Cable H05RN-F 2x0,75

Cable H05RN-F de Neopreno, sección 2x0,75.
Adecuado para el uso al exteriores.

Cavo H05RN-F 5m

CoL.	Code
	LB1070004

Cavo H05RN-F 10m

CoL.	Code
	LB1070005

Cavo H05RN-F 15m

CoL.	Code
	LB1070006

Cavo H05RN-F 20m

CoL.	Code
	LB1070007

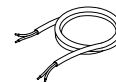

Armatura da incasso CNC 25

Armatura da incasso in termoplastico.

Thermoplastic recess box CNC25

Thermoplastic recess box.

Armature à encastrer CNC25

Armature à encastrer en matériau thermoplastique.

Caja de empotrar CNC25

Caja de empotrar de material termoplástico.

CoL.	Code
	LB1190001

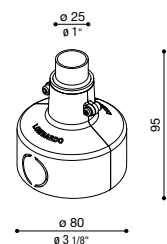

CNC 25 2.0 T

CNC 35 2.0

Installazione

Installation
Installation
Instalación

Incasso terra - Incasso parete - Incasso soffitto

Ground recess - Wall recess - Ceiling recess
Encastrement au sol - Encastrement au mur - Encastrement au plafond
Empotrar suelo - Empotrar pared - Empotrar techo

Materiali

Materials
Materiali
Materiales

Materiale Corpo: Alluminio, Acciaio AISI316L | Tipo di diffusore: Vetro | Trattamento: Anodizzazione

Material: Aluminium, Stainless steel AISI316L | Diffuser type: Glass | Treatment: Anodization
Matériel du corps: Aluminium, Acier inox AISI316L | Type de diffuseur: Verre | Traitement: Anodisation
Material del cuerpo: Aluminio, Acero AISI316L | Tipo de difusor: Cristal | Tratamiento: Anodización

Alimentazione

Power supply
Alimentation
Alimentación

24V - 500mA - 6V

Versioni

Versions
Versions
Versiones

HONEYCOMB | Cavo Alimentazione: 0,50 metri H05RN-F 2x0,75

HONEYCOMB | Power cable: 0.50 m H05RN-F 2x0.75
HONEYCOMB | Câble d'alimentation: 0,50 m H05RN-F 2x0,75
HONEYCOMB | Cable de alimentación: 0,50 m H05RN-F 2x0,75



CNC 35 2.0
T



CNC 35 2.0
T FULL RESIN



CNC 35 2.0
Q



CNC 35 2.0
Q FULL RESIN



Scopri la gamma
Discover the range
Découvrez la gamme
Descubre la gama

COLOURS



Sandblasted Grey



Grey anthracite RAL 7021



Corten



White RAL 9010



Black PVD

CNC 35 2.0 T

IP67 IK 10 20J xx9 	LED			COL.	CODE *	
	W	LM	REAL LM			
	2	150	147	⊗ 24V	LT158100□□ LT15810E□□ LT15810K□□ LT15810W□□ LT15810B□□	
	2	150	97	⊗ 24V	LT15810HO□□ LT15810HE□□ LT15810HK□□ LT15810HW□□ LT15810HB□□	
2	150	147	⊗ 500mA - 6V	LZ158100□□ LZ15810E□□ LZ15810K□□ LZ15810W□□ LZ15810B□□		
2	150	97	⊗ 500mA - 6V	LZ15810HO□□ LZ15810HE□□ LZ15810HK□□ LZ15810HW□□ LZ15810HB□□		

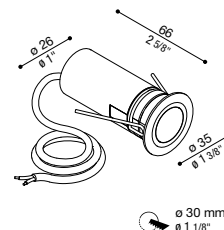

* Complete the CODE ○ OPTIC S | 20° M | 30° L | 45° D | Diff. □ LED COLOUR N | 4000K 3 | 3000K 2 | 2700K 1 | 2200K

Versione Honeycomb non disponibile con ottica D. | Optic D not available for Honeycomb version. | Optique D non disponible pour la version Honeycomb. | La óptica Diff. no está disponible para la versión Honeycomb.

CNC 35 2.0 T Full Resin



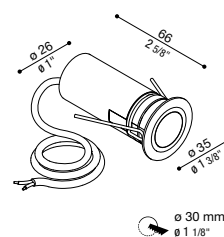



























IP69 / IP 67 IK 10 20J xx9 	LED			COL.	CODE *
	W	LM	REAL LM		
2	150	48	⊗ 24V	LT158100F□□ LT15810EF□□ LT15810KF□□ LT15810WF□□ LT15810BF□□	
2	150	48	⊗ 500mA - 6V	LZ158100F□□ LZ15810EF□□ LZ15810KF□□ LZ15810WF□□ LZ15810BF□□	



* Complete the CODE □ LED COLOUR N | 4000K 3 | 3000K 2 | 2700K 1 | 2200K

Versione Full Resin: nuova tecnologia di incapsulamento dei led e circuiti elettronici che allunga la durata del prodotto. Presenta vetro diffuso. | Full Resin version: new LED and circuit encapsulation technology that extends product life. Features diffused glass. | Version Full Resin: nouvelle technologie d'encapsulation des LED et circuit électronique qui prolonge la durée de vie du produit. Comprend un verre diffus. | Versión Full Resin: nueva tecnología de encapsulación de LED y circuitos electrónicos que prolongan la vida útil del producto. Incorpora cristal difuso.

CNC 35 2.0 Q



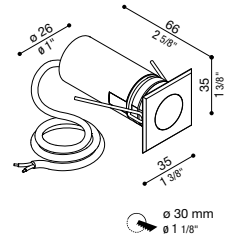











IP67 IK 10 20J xx9 500 ^{KG} MAX CE UK CR	LED			COL.	CODE *
	W	LM	REAL LM		
	2	150	147	 ⊗ 24V	 LT158110□□
					 LT15811E□□
					 LT15811K□□
					 LT15811W□□
 LT15811B□□					
	2	150	97	 ⊗ 24V 	 LT15811H0□□
					 LT15811HE□□
					 LT15811HK□□
					 LT15811HW□□
 LT15811HB□□					
	2	150	147	 ⊗ 500mA - 6V	 LZ158110□□
					 LZ15811E□□
					 LZ15811K□□
					 LZ15811W□□
 LZ15811B□□					
	2	150	97	 ⊗ 500mA - 6V 	 LZ15811H0□□
					 LZ15811HE□□
					 LZ15811HK□□
					 LZ15811HW□□
 LZ15811HB□□					



* Complete the CODE ○ OPTIC S | 20° M | 30° L | 45° D | Diff. □ LED COLOUR N | 4000K 3 | 3000K 2 | 2700K 1 | 2200K

Versione Honeycomb non disponibile con ottica D. | Optic D not available for Honeycomb version. | Optique D non disponible pour la version Honeycomb. | La óptica Diff. no está disponible para la versión Honeycomb.

CNC 35 2.0 Q Full Resin

IP69 / IP 67 IK 10 20J xx9 500 ^{KG} MAX CE UK CR	LED			COL.	CODE *
	W	LM	REAL LM		
 	2	150	48	 ⊗ 24V	 LT158110F□
					 LT15811EF□
					 LT15811KF□
					 LT15811WF□
 LT15811BF□					
	2	150	48	 ⊗ 500mA - 6V	 LZ158110F□
					 LZ15811EF□
					 LZ15811KF□
					 LZ15811WF□
 LZ15811BF□					

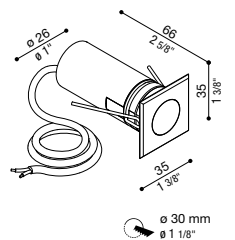

* Complete the CODE □ LED COLOUR N | 4000K 3 | 3000K 2 | 2700K 1 | 2200K

Versione Full Resin: nuova tecnologia di incapsulamento dei led e circuiti elettronici che allunga la durata del prodotto. Presenta vetro diffuso. | Full Resin version: new LED and circuit encapsulation technology that extends product life. Features diffused glass. | Version Full Resin: nouvelle technologie d'encapsulation des LED et circuit électronique qui prolonge la durée de vie du produit. Comprend un verre diffus. | Versión Full Resin: nueva tecnología de encapsulación de LED y circuitos electrónicos que prolongan la vida útil del producto. Incorpora cristal difuso.

Alimentatori CNC 35 in tensione costante 12/24V

CNC 35 ballasts in constant tension 12/24V	12V			24V		
	N° max	IP	Code	N° max	IP	Code
Alimentations CNC 35 en tension 12/24V	1/6	20	LB1070025	1/6	20	LB1070029
	1/12	20	LB1070026	1/12	20	LB1070030
Alimentadores CNC 35 de tensión constante 12/24V	1/8	67	LB1070027	1/8	67	LB1070031
	1/15	67	LB1070028	1/15	67	LB1070032
				1/20 0-10V	67	LB1070113
				1/20 DALI	67	LB1070114

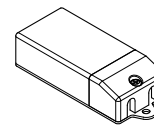

Alimentatori CNC 35 in corrente costante

CNC 35 ballasts in constant current	350mA			500mA		
	N° max	IP	Code	N° max	IP	Code
Alimentations CNC 35 en courant constant	1/2	20	LB1070008	1/2	20	LB1070015
	1/4	20	LB1070009	1/4	20	LB1070016
	5/10	20	LB1070011	5/10	20	LB1070018
Alimentadores CNC 35	1/2 1-10V PUSH	20	LB1070012	1/12 1-10V PUSH	20	LB1070019
	2/4	67	LB1070013	1/4	67	LB1070020
	5/10	67	LB1070014	5/10	67	LB1070021
	2/9 DALI	20	LB1070064	2/9 DALI	20	LB1070064
			1/7 1-10V PUSH	20	LB1070043	

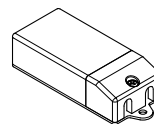

Cavo H05RN-F 2x0,75

Cavo H05RN-F in Neoprene, sezione 2x0,75.
Adatto ad uso esterno.

Cable type H05RN-F 2x0,75
Cable type H05RN-F in Neoprene, section 2x0.75.
Suitable for outdoor use.

Câble H05RN-F 2x0,75
Câble H05RN-F en Néoprène, section 2x0,75.
Également adapté à l'usage à l'extérieur.

Cable H05RN-F 2x0,75
Cable H05RN-F de Neopreno, sección 2x0,75.
Adecuado para el uso al exteriores.

Cavo H05RN-F 5m

CoL.	Code
	LB1070004

Cavo H05RN-F 10m

CoL.	Code
	LB1070005

Cavo H05RN-F 15m

CoL.	Code
	LB1070006

Cavo H05RN-F 20m

CoL.	Code
	LB1070007

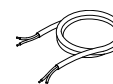

Armatura da incasso CNC 35

Armatura da incasso in termoplastico.

Thermoplastic recess box CNC 35
Thermoplastic recess box.

Armature à encastrer CNC 35
Armature à encastrer en matériau thermoplastique.

Caja de empotrar CNC 35
Caja de empotrar de material termoplástico.

CoL.	Code
	LB1070001

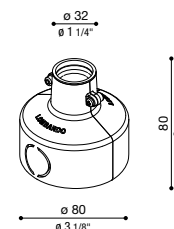

CNC 35 2.0 SWING

Installazione

Installation
Installation
Instalación

Terra - Parete - Soffitto

Ground - Wall - Ceiling
Sol - Mur - Plafond
Suelo - Pared - Techo

Materiali

Materials
Materiali
Materiales

Materiale Corpo: Acciaio AISI316L | Tipo di diffusore: Vetro

Material: Stainless steel AISI316L | Diffuser type: Glass
Matériel du corps: Acier inox AISI316L | Type de diffuseur: Verre
Material del cuerpo: Acero AISI316L | Tipo de difusor: Cristal

Alimentazione

Power supply
Alimentation
Alimentación

24V - 500mA - 6V

Versioni

Versions
Versions
Versiones

HONEYCOMB | Cavo Alimentazione: 1,50 metri H05RN-F 2×0,75

HONEYCOMB | Power cable: 1.50 m H05RN-F 2×0.75
HONEYCOMB | Câble d'alimentation: 1,50 m H05RN-F 2×0,75
HONEYCOMB | Cable de alimentación: 1,50 m H05RN-F 2×0,75



CNC 35 2.0 SWING



**CNC 35 2.0 SWING
SUPERFICIE**



**CNC 35 2.0 SWING
GARDEN 40**



**CNC 35 2.0 SWING
GARDEN 100**



**CNC 35 2.0 SWING
POST 40**



**CNC 35 2.0 SWING
POST 100**



Scopri la gamma
Discover the range
Découvrez la gamme
Descubre la gama

COLOURS



Sandblasted Grey



Grey anthracite RAL 7021



Corten

CNC 35 2.0 Swing

IP67 IK 07 2J xx5 CE UK E5	LED			COL.	CODE *
	W	LM	REAL LM		
	2	150	147	⊗ 24V	LT158310□□
					LT15831E□□
					LT15831K□□
	2	150	97	⊗ 24V	LT15831H0□□
					LT15831HE□□
					LT15831HK□□
	2	150	147	⊗ 500mA - 6V	LZ158310□□
					LZ15831E□□
					LZ15831K□□
	2	150	97	⊗ 500mA - 6V	LZ15831H0□□
					LZ15831HE□□
					LZ15831HK□□

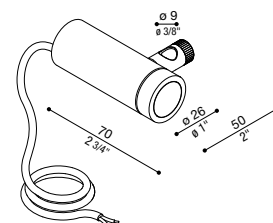

* Complete the CODE ○ OPTIC S | 20° M | 30° L | 45° D | Diff. □ LED COLOUR N | 4000K 3 | 3000K 2 | 2700K 1 | 2200K

Versione Honeycomb non disponibile con ottica D. | Optic D not available for Honeycomb version. | Optique D non disponible pour la version Honeycomb. | La óptica Diff. no está disponible para la versión Honeycomb.

CNC 35 2.0 Swing Superficie

IP67 IK 07 2J xx5 CE UK E5	LED			COL.	CODE *
	W	LM	REAL LM		
	2	150	147	⊗ 24V	LT158300□□
					LT15830E□□
					LT15830K□□
	2	150	97	⊗ 24V	LT15830H0□□
					LT15830HE□□
					LT15830HK□□
	2	150	147	⊗ 500mA - 6V	LZ158300□□
					LZ15830E□□
					LZ15830K□□
	2	150	97	⊗ 500mA - 6V	LZ15830H0□□
					LZ15830HE□□
					LZ15830HK□□

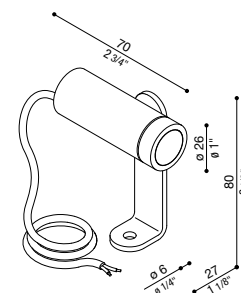

* Complete the CODE ○ OPTIC S | 20° M | 30° L | 45° D | Diff. □ LED COLOUR N | 4000K 3 | 3000K 2 | 2700K 1 | 2200K

Versione Honeycomb non disponibile con ottica D. | Optic D not available for Honeycomb version. | Optique D non disponible pour la version Honeycomb. | La óptica Diff. no está disponible para la versión Honeycomb.

CNC 35 2.0 Swing Garden 40

IP67 IK 07 2J xx5 CE UK E5	LED			COL.	CODE *
	W	LM	REAL LM		
	2	150	147	× 24V	LT158320□□
					LT15832E□□
					LT15832K□□
	2	150	97	× 24V	LT15832H0□□
					LT15832HE□□
					LT15832HK□□
	2	150	147	× 500mA - 6V	LZ158320□□
					LZ15832E□□
					LZ15832K□□
	2	150	97	× 500mA - 6V	LZ15832H0□□
					LZ15832HE□□
					LZ15832HK□□

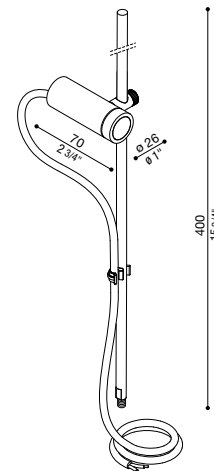

* Complete the CODE ○ OPTIC S | 20° M | 30° L | 45° D | Diff. □ LED COLOUR N | 4000K 3 | 3000K 2 | 2700K 1 | 2200K

Versione Honeycomb non disponibile con ottica D. | Optic D not available for Honeycomb version. | Optique D non disponible pour la version Honeycomb. | La óptica Diff. no está disponible para la versión Honeycomb.

CNC 35 2.0 Swing Garden 100



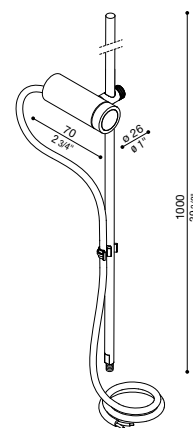













IP67 IK 07 2J xx5 CE UK E5	LED			COL.	CODE *
	W	LM	REAL LM		
	2	150	147	× 24V	LT158330□□
					LT15833E□□
					LT15833K□□
	2	150	97	× 24V	LT15833H0□□
					LT15833HE□□
					LT15833HK□□
	2	150	147	× 500mA - 6V	LZ158330□□
					LZ15833E□□
					LZ15833K□□
	2	150	97	× 500mA - 6V	LZ15833H0□□
					LZ15833HE□□
					LZ15833HK□□



* Complete the CODE ○ OPTIC S | 20° M | 30° L | 45° D | Diff. □ LED COLOUR N | 4000K 3 | 3000K 2 | 2700K 1 | 2200K

Versione Honeycomb non disponibile con ottica D. | Optic D not available for Honeycomb version. | Optique D non disponible pour la version Honeycomb. | La óptica Diff. no está disponible para la versión Honeycomb.

CNC 35 2.0 Swing Post 40



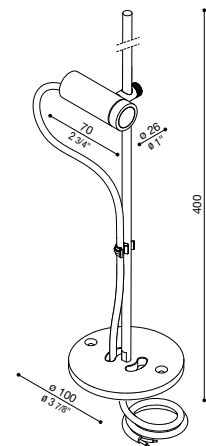













IP67 IK 07 2J xx5 CE UK CA	LED			COL.	CODE *				
	W	LM	REAL LM						
	2	150	147	  24V	 LT158340□□  LT15834E□□  LT15834K□□				
					2	150	97	  24V 	 LT15834H0□□  LT15834HE□□  LT15834HK□□
									2
	2	150	97	  500mA - 6V 	 LZ15834H0□□  LZ15834HE□□  LZ15834HK□□				



* Complete the CODE ○ OPTIC S | 20° M | 30° L | 45° D | Diff. □ LED COLOUR N | 4000K 3 | 3000K 2 | 2700K 1 | 2200K

Versione Honeycomb non disponibile con ottica D. | Optic D not available for Honeycomb version. | Optique D non disponible pour la version Honeycomb. | La óptica Diff. no está disponible para la versión Honeycomb.

CNC 35 2.0 Swing Post 100

IP67 IK 07 2J xx5 CE UK CA	LED			COL.	CODE *				
	W	LM	REAL LM						
	2	150	147	  24V	 LT158350□□  LT15835E□□  LT15835K□□				
					2	150	97	  24V 	 LT15835H0□□  LT15835HE□□  LT15835HK□□
									2
	2	150	97	  500mA - 6V 	 LZ15835H0□□  LZ15835HE□□  LZ15835HK□□				

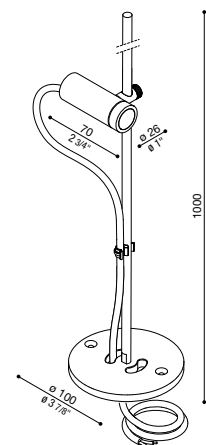

* Complete the CODE ○ OPTIC S | 20° M | 30° L | 45° D | Diff. □ LED COLOUR N | 4000K 3 | 3000K 2 | 2700K 1 | 2200K

Versione Honeycomb non disponibile con ottica D. | Optic D not available for Honeycomb version. | Optique D non disponible pour la version Honeycomb. | La óptica Diff. no está disponible para la versión Honeycomb.

Alimentatori CNC 35 in tensione costante 12/24V

CNC 35 ballasts in constant tension 12/24V	12V			24V		
	N° max	IP	Code	N° max	IP	Code
Alimentations CNC 35 en tension 12/24V	1/6	20	LB1070025	1/6	20	LB1070029
	1/12	20	LB1070026	1/12	20	LB1070030
Alimentadores CNC 35 de tensión constante 12/24V	1/8	67	LB1070027	1/8	67	LB1070031
	1/15	67	LB1070028	1/15	67	LB1070032
				1/20 0-10V	67	LB1070113
			1/20 DALI	67	LB1070114	

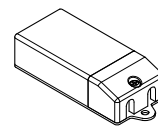
Alimentatori CNC 35 in corrente costante

CNC 35 ballasts in constant current	350mA			500mA		
	N° max	IP	Code	N° max	IP	Code
Alimentations CNC 35 en courant constant	1/2	20	LB1070008	1/2	20	LB1070015
	1/4	20	LB1070009	1/4	20	LB1070016
	5/10	20	LB1070011	5/10	20	LB1070018
Alimentadores CNC 35	1/2 1-10V PUSH	20	LB1070012	1/12 1-10V PUSH	20	LB1070019
	2/4	67	LB1070013	1/4	67	LB1070020
	5/10	67	LB1070014	5/10	67	LB1070021
	2/9 DALI	20	LB1070064	2/9 DALI	20	LB1070064
			1/7 1-10V PUSH	20	LB1070043	

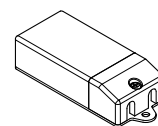
Cavo H05RN-F 2x0,75

Cavo H05RN-F in Neoprene, sezione 2x0,75. Adatto ad uso esterno.

Cable type H05RN-F 2x0,75

Cable type H05RN-F in Neoprene, section 2x0.75. Suitable for outdoor use.

Câble H05RN-F 2x0,75

Câble H05RN-F en Néoprène, section 2x0,75. Également adapté à l'usage à l'extérieur.

Cable H05RN-F 2x0,75

Cable H05RN-F de Neopreno, sección 2x0,75. Adecuado para el uso al exteriores.

Cavo H05RN-F 5m

CoL.	Code
	LB1070004

Cavo H05RN-F 15m

CoL.	Code
	LB1070006

Cavo H05RN-F 10m

CoL.	Code
	LB1070005

Cavo H05RN-F 20m

CoL.	Code
	LB1070007

Accessorio giardino per CNC

Accessorio da giardino da abbinare a CNC 35 Swing Superficie 2.0, realizzato in metallo zincato a freddo. Adatto per uso esterno. Idoneo per installazione a terra.

CoL.	Code
	LB1070002

Garden accessory

Garden accessory for use with CNC 35 Swing Superficie 2.0, made of cold galvanized metal. Suitable for outdoor use and ground application.

Accessoire de jardin

Accessoire de jardin à associer à CNC 35 Swing Superficie 2.0, réalisé en métal zingué à froid. Également adapté à l'usage à l'extérieur. Convient pour une utilisation au sol.

Accesorio para jardín

Accesorio de jardín a acoplar a CNC 35 Swing Superficie 2.0, realizado en metal galvanizado en frío. Adecuado para el uso al exteriores. Idóneo para instalación en el suelo.

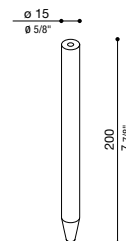

CNC 35 2.0 SWING GARDEN 100



CNC 35 2.0 SWING GARDEN 4.0





FEATURES

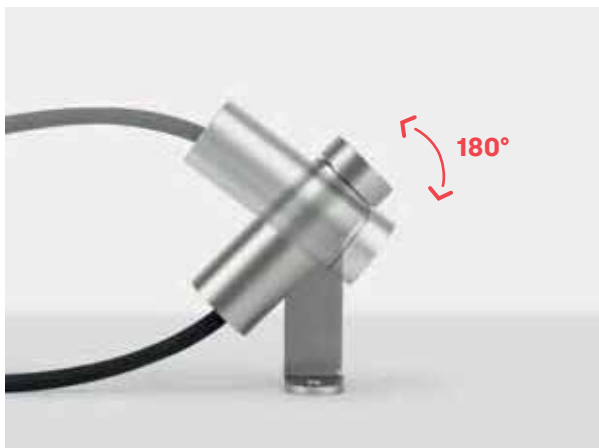

↘ **Rotazione di 180°.**
180° rotation.
Rotation à 180°.
Rotación de 180°.

.....



H140 CM

CNC 35 2.0 Swing Post

H100 CM

CNC 35 2.0 Swing Garden



CNC 35 2.0 SWING SUPERFICIE



CNC 35 2.0 SWING SUPERFICIE

CNC 35 2.0 SWING GARDEN



CNC 50 2.0

Installazione

Installation
Installation
Instalación

Incasso terra - Incasso parete - Incasso soffitto

Ground recess - Wall recess - Ceiling recess
Encastrement au sol - Encastrement au mur - Encastrement au plafond
Empotrar suelo - Empotrar pared - Empotrar techo

Materiali

Materials
Materiali
Materiales

Materiale Corpo: Alluminio, Acciaio AISI316L | Tipo di diffusore: Vetro | Trattamento: Anodizzazione

Material: Aluminium, Stainless steel AISI316L | Diffuser type: Glass | Treatment: Anodization
Matériel du corps: Aluminium, Acier inox AISI316L | Type de diffuseur: Verre | Traitement: Anodisation
Material del cuerpo: Aluminio, Acero AISI316L | Tipo de difusor: Cristal | Tratamiento: Anodización

Alimentazione

Power supply
Alimentation
Alimentación

24V - 500mA - 15V

Versioni

Versions
Versions
Versiones

HONEYCOMB | Cavo Alimentazione: 0,50 metri H05RN-F 2×0,75

HONEYCOMB | Power cable: 0.50 m H05RN-F 2×0.75

HONEYCOMB | Câble d'alimentation: 0,50 m H05RN-F 2×0,75

HONEYCOMB | Cable de alimentación: 0,50 m H05RN-F 2×0,75



CNC 50 2.0
T



CNC 50 2.0
T FULL RESIN



Scopri la gamma
Discover the range
Découvrez la gamme
Descubre la gama

COLOURS



Sandblasted Grey



Grey anthracite RAL 7021



Corten



White RAL 9010



Black PVD

CNC 50 2.0 T

IP67 IK 10 20J xx9 500 ^{KG} MAX	LED			COL.	CODE *	
	W	LM	REAL LM			
	6,5	694	575	⊗ 24V	LT158200□□ LT15820E□□ LT15820K□□ LT15820W□□ LT15820B□□	
	6,5	694	392	⊗ 24V	LT15820HO□□ LT15820HE□□ LT15820HK□□ LT15820HW□□ LT15820HB□□	
6,5	694	575	⊗ 500mA - 15V	LZ158200□□ LZ15820E□□ LZ15820K□□ LZ15820W□□ LZ15820B□□		
6,5	694	392	⊗ 500mA - 15V	LZ15820HO□□ LZ15820HE□□ LZ15820HK□□ LZ15820HW□□ LZ15820HB□□		

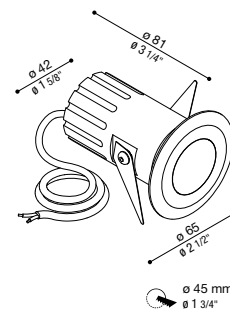

* Complete the CODE OPTIC S | 25° M | 30° L | 50° D | Diff. LED COLOUR N | 4000K 3 | 3000K 2 | 2700K 1 | 2200K

Versione Honeycomb non disponibile con ottica D. | Optic D not available for Honeycomb version. | Optique D non disponible pour la version Honeycomb. | La óptica Diff. no está disponible para la versión Honeycomb.

CNC 50 2.0 T Full Resin

IP69 / IP 67 IK 10 20J xx9 500 ^{KG} MAX	LED			COL.	CODE *	
	W	LM	REAL LM			
	6,5	694	252	⊗ 24V	LT158200F□ LT15820EF□ LT15820KF□ LT15820WF□ LT15820BF□	
	6,5	694	252	⊗ 500mA - 15V	LZ158200F□ LZ15820EF□ LZ15820KF□ LZ15820WF□ LZ15820BF□	

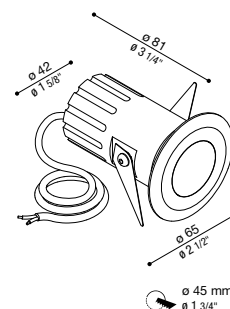

* Complete the CODE LED COLOUR N | 4000K 3 | 3000K 2 | 2700K 1 | 2200K

Versione Full Resin: nuova tecnologia di incapsulamento dei led e circuiti elettronici che allunga la durata del prodotto. Presenta vetro diffuso. | Full Resin version: new LED and circuit encapsulation technology that extends product life. Features diffused glass. | Version Full Resin: nouvelle technologie d'encapsulation des LED et circuit électronique qui prolonge la durée de vie du produit. Comprend un verre diffus. | Versión Full Resin: nueva tecnología de encapsulación de LED y circuitos electrónicos que prolongan la vida útil del producto. Incorpora cristal difuso.

Alimentatori CNC 50 in tensione costante 24V

CNC 50 ballasts in constant tension 24V available

Alimentations CNC 50 en tension 24V

Alimentadores CNC 50 de tensión constante 24V

N° max	IP	Code
1/2	20	LB1070029
1/4	20	LB1070030
1/5	67	LB1070031
1/7	67	LB1070032
1/8 0-10V	67	LB1070113
1/8 DALI	67	LB1070114

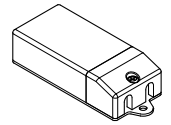

Alimentatori CNC 50 in corrente costante

CNC 50 ballasts in constant current

Alimentations CNC 50 en courant constant

Alimentadores CNC 50

350mA			500mA		
N° max	IP	Code	N° max	IP	Code
1	20	LB1070009	1	20	LB1070016
1/3	20	LB1070011	1/3	20	LB1070018
1/3 1-10V PUSH	20	LB1070012	1/3 1-10V PUSH	20	LB1070019
1/2	67	LB1070013	1/2	67	LB1070020
1/3	67	LB1070014	2/4	67	LB1070021
1/3 DALI	20	LB1070064	1/3 DALI	20	LB1070064

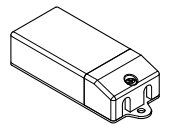

Cavo H05RN-F 2x0,75

Cavo H05RN-F in Neoprene, sezione 2x0,75. Adatto ad uso esterno.

Cable type H05RN-F 2x0,75

Cable type H05RN-F in Neoprene, section 2x0,75. Suitable for outdoor use.

Câble H05RN-F 2x0,75

Câble H05RN-F en Néoprène, section 2x0,75. Également adapté à l'usage à l'extérieur.

Cable H05RN-F 2x0,75

Cable H05RN-F de Neopreno, sección 2x0,75. Adecuado para el uso al exteriores.

Cavo H05RN-F 5m

CoL.	Code
	LB1070004

Cavo H05RN-F 10m

CoL.	Code
	LB1070005

Cavo H05RN-F 15m

CoL.	Code
	LB1070006

Cavo H05RN-F 20m

CoL.	Code
	LB1070007



Armatura da incasso CNC 50

Armatura da incasso in termoplastico.

Recess box CNC 50

Thermoplastic recess box.

Boîte d'encastrement CNC 50

Armature à encastrer en matériau thermoplastique.

Caja de empotrar CNC 50

Caja de empotrar de material termoplástico.

CoL.	Code
	LB1070039

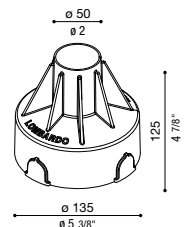



FEATURES



- 
Scheda di conversione.
 Conversion board.
 Dispositif de conversion.
 Dispositivo de conversión.



- 
Ghiera con rivestimento PVD (Physical Vapor Deposition), processo di deposizione di materiale mediante la vaporizzazione e la condensazione di un metallo di partenza. Questo trattamento offre maggiore resistenza all'usura e corrosione rispetto alle tradizionali verniciature.

PVD (Physical Vapor Deposition) coating, a process of deposition of material through the vaporisation and condensation of a starting metal. This treatment offers greater resistance to wear and corrosion than traditional coatings.

Le revêtement PVD (Physical Vapor Deposition) est un procédé de dépôt de matériaux par vaporisation et condensation d'un métal de départ. Ce traitement offre une plus grande résistance à l'usure et à la corrosion que les revêtements traditionnels.

Recubrimiento PVD (Physical Vapor Deposition), un proceso de deposición de material mediante la vaporización y condensación de un metal de partida. Este tratamiento ofrece mayor resistencia al desgaste y la corrosión que los revestimientos tradicionales.

- 
Aquastop integrato.
 Integrated aquastop.
 Aquastop intégré.
 Aquastop integrado.



Versione HONEYCOMB.
 HONEYCOMB version.
 Version HONEYCOMB (nid d'abeille).
 Versión HONEYCOMB.

Versione Full Resin.
 Full Resin version.
 Version Full Resin.
 Versión Full Resin.

Versione standard.
 Standard version.
 Version Standard.
 Versión Standard.



CNC 49

Installazione

Installation
Installation
Instalación

Incasso terra - Terra - Incasso parete - Parete

Ground recess - Ground - Wall recess - Wall
Encastrement au sol - Sol - Encastrement au mur - Mur
Empotrar suelo - Suelo - Empotrar pared - Pared

Materiali

Materials
Materiali
Materiales

Tipo di diffusore: Policarbonato

Diffuser type: Polycarbonate
Type de diffuseur: Polycarbonate
Tipo de difusor: Policarbonato

Alimentazione

Power supply
Alimentation
Alimentación

24V

Versioni

Versions
Versions
Versiones

Cavo Alimentazione: 0,50 metri H05RN-F 2×0,75

Power cable: 0.50 m H05RN-F 2×0.75
Câble d'alimentation: 0,50 m H05RN-F 2×0,75
Cable de alimentación: 0,50 m H05RN-F 2×0,75



CNC 49
CL



CNC 49
C2L



CNC 49
C4L



CNC 49
C180



CNC 49
QL



CNC 49
Q2L



CNC 49
Q4L



COLOURS



Polished stainless steel



White RAL 9010



Grey High Tech RAL 9006



Grey anthracite RAL 7021



Corten

CNC 49 CL

IP67 K 10 20J xx9 ↓ 500 KG MAX ⚡ 53°C MAX CE UK CA	LED			W LM REAL LM	COL. CODE *	
	2	240	26			

* Complete the CODE LED COLOUR N | 4000K 3 | 3000K 2 | 2700K

CNC 49 C2L

IP67 IK 10 20J xx9 ↓ 500 KG MAX ⚡ 53°C MAX CE UK CA	LED			W LM REAL LM	COL. CODE *	
	2	240	45			

* Complete the CODE LED COLOUR N | 4000K 3 | 3000K 2 | 2700K

CNC 49 C4L

IP67 IK 10 20J xx9 ↓ 500 KG MAX ⚡ 53°C MAX CE UK CA	LED			W LM REAL LM	COL. CODE *	
	2	240	83			

* Complete the CODE LED COLOUR N | 4000K 3 | 3000K 2 | 2700K

CNC 49 C180

IP67 IK 10 20J xx9 ↓ 500 KG MAX ⚡ 53°C MAX CE UK CA	LED			W LM REAL LM	COL. CODE *	
	2	240	37			

* Complete the CODE LED COLOUR N | 4000K 3 | 3000K 2 | 2700K

Versione a 180°. | 180° version. | Version 180°. | Versión 180°.

CNC 49 QL

IP67 IK 10 20J xx9 ↓ 500 KG MAX ⚡ 53°C MAX CE UK CA	LED			W LM REAL LM	COL. CODE *	
	2	240	26			

* Complete the CODE LED COLOUR N | 4000K 3 | 3000K 2 | 2700K

CNC 49 Q2L

IP67 IK 10 20J xx9 500 ^{KG} _{MAX} 53 ^{°C} _{MAX} 	LED			24V	COL. CODE *	LL127110 □ LL12711W □ LL12711G □ LL12711E □ LL12711K □
	W	LM	REAL LM			
	2	240	45			

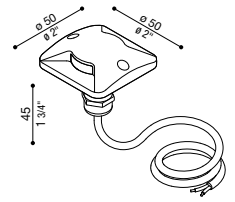

* Complete the CODE □ LED COLOUR N | 4000K 3 | 3000K 2 | 2700K

CNC 49 Q4L

IP67 IK 10 20J xx9 500 ^{KG} _{MAX} 53 ^{°C} _{MAX} 	LED			24V	COL. CODE *	LL127120 □ LL12712W □ LL12712G □ LL12712E □ LL12712K □
	W	LM	REAL LM			
	2	240	83			

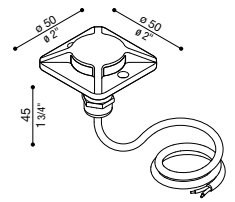

* Complete the CODE □ LED COLOUR N | 4000K 3 | 3000K 2 | 2700K

Accessori | Accessories | Accessoires | Accesorios

Alimentatori CNC 49 in tensione costante 24V

CNC 49 ballasts in constant tension 24V	N° max	IP	Code	N° max	IP	Code
Alimentations CNC 49 en tension 24V	1/10	20	LB1070029	1/20 0-10V	67	LB1070113
Alimentadores CNC 49 de tensión constante 24V	1/16	20	LB1070030	1/20 DALI	67	LB1070114
	1/13	67	LB1070031			
	1/20	67	LB1070032			
	1/7 DALI	20	LB1070065			

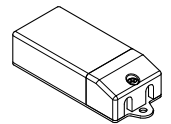

Cavo H05RN-F 2x0,75

Cavo H05RN-F in Neoprene, sezione 2x0,75. Adatto ad uso esterno.

Cable type H05RN-F 2x0,75

Cable type H05RN-F in Neoprene, section 2x0.75. Suitable for outdoor use.

Câble H05RN-F 2x0,75

Câble H05RN-F en Néoprène, section 2x0,75. Également adapté à l'usage à l'extérieur.

Cable H05RN-F 2x0,75

Cable H05RN-F de Neopreno, sección 2x0,75. Adecuado para el uso al exteriores.

Cavo H05RN-F 5m

CoL.	Code
	LB1070004

Cavo H05RN-F 15m

CoL.	Code
	LB1070006

Cavo H05RN-F 10m

CoL.	Code
	LB1070005

Cavo H05RN-F 20m

CoL.	Code
	LB1070007



Armatura da incasso CNC

Armatura da incasso in termoplastico.

Thermoplastic recess box CNC

Thermoplastic recess box.

Armature à encastrer CNC

Armature à encastrer en matériau thermoplastique.

Caja de empotrar CNC

Caja de empotrar de material termoplástico.

CoL.	Code
	LB1190001

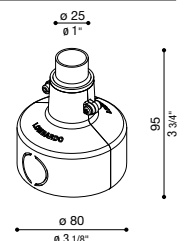

CNC 49 C2L



CNC 49 Q4L



CNC 99

Installazione

Installation
Installation
Instalación

Parete - Terra - Incasso terra - Soffitto

Wall - Ground - Ground recess - Ceiling
Mur - Sol - Encastrément au sol - Plafond
Pared - Suelo - Empotrar suelo - Techo

Materiali

Materials
Materiali
Materiales

Tipo di diffusore: PMMA - Policarbonato

Diffuser type: PMMA - Polycarbonate
Type de diffuseur: PMMA - Polycarbonate
Tipo de difusor: PMMA - Policarbonato

Alimentazione

Power supply
Alimentation
Alimentación

24V

Versioni

Versions
Versions
Versiones

Cavo Alimentazione: 0,50 metri H05RN-F 2×0,75

Power cable: 0.50 m H05RN-F 2×0.75
Câble d'alimentation: 0,50 m H05RN-F 2×0,75
Cable de alimentación: 0,50 m H05RN-F 2×0,75



CNC 99
CL



CNC 99
C2L



CNC 99
C4L



CNC 99
C180



CNC 99
C UP



CNC 99
QL



CNC 99
Q2L



CNC 99
Q4L



COLOURS



Polished stainless steel



White RAL 9010



Grey High Tech RAL 9006





Grey anthracite RAL 7021



Corten

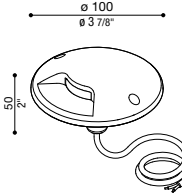

CNC 99 CL

IP67 IK 10 20J xx9 2000 KG MAX 53°C MAX CE UK CA	LED			W LM REAL LM	COL. CODE *	
	W	LM	REAL LM			
	5	470	45	 24V	LL137000□ LL13700W□ LL13700G□ LL13700E□ LL13700K□	

* Complete the CODE □ LED COLOUR N | 4000K 3 | 3000K 2 | 2700K

Tutti i modelli, se installati con armatura cod. LB1230001, diventano calpestabile. Cod. LL137000N/3/2 ghiera in acciaio inox. | When installed with recess box code LB1230001, all models are walk-over. Cod. LL137000N/3/2 stainless steel retaining ring. | Tous les modèles, lorsqu'ils sont installés avec le code d'armure LB1230001, deviennent praticables. Cod. LL137000N/3/2 colerette en acier inox. | Todos los modelos, cuando se instalan con la caja de empotrar cod. LB1230001, se vuelven transitables. Cod. LL137000N/3/2 casquillos de acero inoxidable.

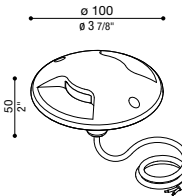

CNC 99 C2L

IP67 IK 10 20J xx9 2000 KG MAX 53°C MAX CE UK CA	LED			W LM REAL LM	COL. CODE *	
	W	LM	REAL LM			
	5	470	100	 24V	LL137010□ LL13701W□ LL13701G□ LL13701E□ LL13701K□	

* Complete the CODE □ LED COLOUR N | 4000K 3 | 3000K 2 | 2700K

Tutti i modelli, se installati con armatura cod. LB1230001, diventano calpestabile. Cod. LL137010N/3/2 ghiera in acciaio inox. | Bidirectional version. When installed with recess box code LB1230001, all models are walk-over. Cod. LL137010N/3/2 stainless steel retaining ring. | Tous les modèles, lorsqu'ils sont installés avec le code d'armure LB1230001, deviennent praticables. Cod. LL137010N/3/2 colerette en acier inox. | Todos los modelos, cuando se instalan con la caja de empotrar cod. LB1230001, se vuelven transitables. Cod. LL137010N/3/2 casquillos de acero inoxidable.

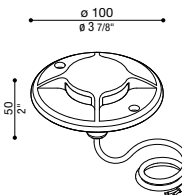

CNC 99 C4L

IP67 IK 10 20J xx9 2000 KG MAX 53°C MAX CE UK CA	LED			W LM REAL LM	COL. CODE *	
	W	LM	REAL LM			
	5	470	200	 24V	LL137020□ LL13702W□ LL13702G□ LL13702E□ LL13702K□	

* Complete the CODE □ LED COLOUR N | 4000K 3 | 3000K 2 | 2700K

Tutti i modelli, se installati con armatura cod. LB1230001, diventano calpestabile. Cod. LL137020N/3/2 ghiera in acciaio inox. | When installed with recess box code LB1230001, all models are walk-over. Cod. LL137020N/3/2 stainless steel retaining ring. | Tous les modèles, lorsqu'ils sont installés avec le code d'armure LB1230001, deviennent praticables. Cod. LL137020N/3/2 colerette en acier inox. | Todos los modelos, cuando se instalan con la caja de empotrar cod. LB1230001, se vuelven transitables. Cod. LL137020N/3/2 casquillos de acero inoxidable.

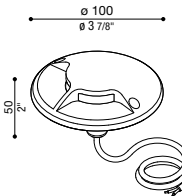





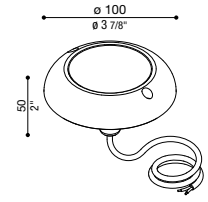

CNC 99 C180

IP67 IK 10 20J xx9 2000 KG MAX 53°C MAX CE UK CA	LED			W LM REAL LM	COL. CODE *	
	W	LM	REAL LM			
	5	470	93	 24V	LL137030□ LL13703W□ LL13703G□ LL13703E□ LL13703K□	

* Complete the CODE □ LED COLOUR N | 4000K 3 | 3000K 2 | 2700K

Versione a 180°. Tutti i modelli, se installati con armatura cod. LB1230001, diventano calpestabile. Cod. LL137030N/3/2 ghiera in acciaio inox. | 180° version. When installed with recess box code LB1230001, all models are walk-over. Cod. LL137030N/3/2 stainless steel retaining ring. | Version 180°. Tous les modèles, lorsqu'ils sont installés avec le code d'armure LB1230001, deviennent praticables. Cod. LL137030N/3/2 colerette en acier inox. | Versión 180°. Todos los modelos, cuando se instalan con la caja de empotrar cod. LB1230001, se vuelven transitables. Cod. LL137030N/3/2 casquillos de acero inoxidable.







CNC 99 C Up

IP67 IK 10 20J xx9 ↓ 500 KG MAX ↑ 53°C MAX CE UK CA	LED			COL.	CODE *	
	W	LM	REAL LM			
	5	470	173	 ⊗ 24V	<ul style="list-style-type: none">  LL137040□  LL13704W□  LL13704G□  LL13704E□  LL13704K□ 	

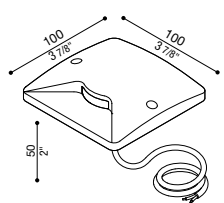
* Complete the CODE □ LED COLOUR N | 4000K 3 | 3000K 2 | 2700K

Cod. LL137040N/3/2 ghiera in acciaio inox. Diffusore in policarbonato, effetto poliGLASS. | Cod. LL137040N/3/2 stainless steel retaining ring. Polycarbonate diffuser, polyGLASS effect. | Cod. LL137040N/3/2 collerette en acier inox. Diffuseur en polycarbonate, effet polyGLASS. | Cod. LL137040N/3/2 casquillos de acero inoxidable. Difusor de policarbonato, efecto polyGLASS.







CNC 99 QL

IP67 IK 10 20J xx9 ↓ 2000 KG MAX ↑ 53°C MAX CE UK CA	LED			COL.	CODE *	
	W	LM	REAL LM			
	5	470	52	 ⊗ 24V	<ul style="list-style-type: none">  LL13710W□  LL13710G□  LL13710E□  LL13710K□ 	

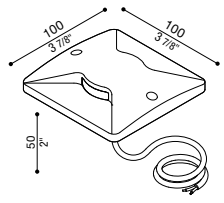
* Complete the CODE □ LED COLOUR N | 4000K 3 | 3000K 2 | 2700K

Tutti i modelli, se installati con armatura cod. LB1230001, diventano calpestabile. | When installed with recess box code LB1230001, all models are walk-over. | Tous les modèles, lorsqu'ils sont installés avec le code d'armure LB1230001, deviennent praticables. | Todos los modelos, cuando se instalan con la caja de empotrar cod. LB1230001, se vuelven transitables.







CNC 99 Q2L

IP67 IK 10 20J xx9 ↓ 2000 KG MAX ↑ 53°C MAX CE UK CA	LED			COL.	CODE *	
	W	LM	REAL LM			
	5	470	98	 ⊗ 24V	<ul style="list-style-type: none">  LL13711W□  LL13711G□  LL13711E□  LL13711K□ 	

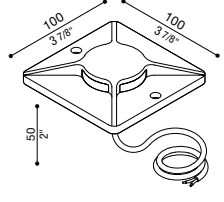
* Complete the CODE □ LED COLOUR N | 4000K 3 | 3000K 2 | 2700K

Tutti i modelli, se installati con armatura cod. LB1230001, diventano calpestabile. | When installed with recess box code LB1230001, all models are walk-over. | Tous les modèles, lorsqu'ils sont installés avec le code d'armure LB1230001, deviennent praticables. | Todos los modelos, cuando se instalan con la caja de empotrar cod. LB1230001, se vuelven transitables.

CNC 99 Q4L

IP67 IK 10 20J xx9 ↓ 2000 KG MAX ↑ 53°C MAX CE UK CA	LED			COL.	CODE *	
	W	LM	REAL LM			
	5	470	170	 ⊗ 24V	<ul style="list-style-type: none">  LL13712W□  LL13712G□  LL13712E□  LL13712K□ 	

* Complete the CODE □ LED COLOUR N | 4000K 3 | 3000K 2 | 2700K

Tutti i modelli, se installati con armatura cod. LB1230001, diventano calpestabile. | When installed with recess box code LB1230001, all models are walk-over. | Tous les modèles, lorsqu'ils sont installés avec le code d'armure LB1230001, deviennent praticables. | Todos los modelos, cuando se instalan con la caja de empotrar cod. LB1230001, se vuelven transitables.

Alimentatori CNC 99 in tensione costante 24V

CNC 99 ballasts in constant tension 24V	N° max	IP	Code	N° max	IP	Code
Alimentations CNC 99 en tension 24V	1/5	20	LB1070029	1/6 DALI	20	LB1070065
	1/8	20	LB1070030	1/10 0-10V	67	LB1070113
	1/5	67	LB1070031	1/10 DALI	67	LB1070114
Alimentadores CNC 99 de tensión constante 24V	1/10	67	LB1070032			

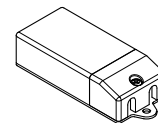

Cavo H05RN-F 2x0,75

**Cavo H05RN-F in Neoprene, sezione 2x0,75.
Adatto ad uso esterno.**

Cable type H05RN-F in Neoprene, section 2x0.75.
Suitable for outdoor use.

Câble H05RN-F en Néoprène, section 2x0,75.
Également adapté à l'usage à l'extérieur.

Cable H05RN-F de Neopreno, sección 2x0,75.
Adecuado para el uso al exteriores.

Cavo H05RN-F 5m	
CoL.	Code
	LB1070004

Cavo H05RN-F 10m	
CoL.	Code
	LB1070005

Cavo H05RN-F 15m	
CoL.	Code
	LB1070006

Cavo H05RN-F 20m	
CoL.	Code
	LB1070007



Armatura da incasso CNC

Armatura da incasso in termoplastico.

Thermoplastic recess box CNC
Thermoplastic recess box.

Armature à encastrer CNC
Armature à encastrer en matériau thermoplastique.

Caja de empotrar CNC
Caja de empotrar de material termoplástico.

CoL.	Code
	LB1230001

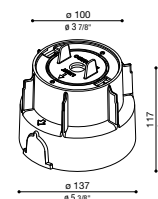

CNC 99 C4L



FEATURES

Finto incasso.

Surface mounted.

Faux encastré.

Montaje en superficie.

Cavo di alimentazione
Power cable
Câble d'alimentation
Cable de alimentación

Pavimentazione
Floor
Sol
Suelo

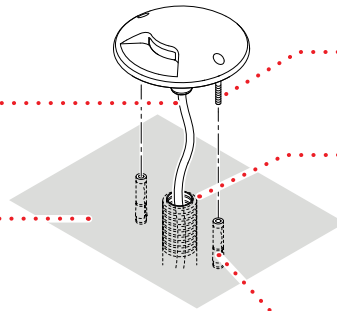

Tasselli M4
Anchor screws M4
Chevilles M4
Tornillos M4

Tubo corrugato
Corrugated duct
Tube annelé
Tubo corrugado

Fissaggio tramite tasselli ad espansione ø8 mm

Fixing by means of anchor screws ø8 mm

Fixation par chevilles à expansion ø8 mm

Fijación mediante tornillos de expansión ø8mm



Versioni disponibili.

Available versions.

Versions disponibles.

Versiones disponibles.

* Versione in acciaio inox.

Stainless steel version.

Version en acier inox.

Versión en acero inoxidable.

CNC 99 C2L



CNC 99 Q2L



CNC 99 Q1



CNC 100

Installazione

Installation
Installation
Instalación

Incasso terra

Ground recess
Encastrement au sol
Empotrar suelo

Materiali

Materials
Materiali
Materiales

Materiale Corpo: Alluminio | Tipo di diffusore: Policarbonato

Material: Aluminium | Diffuser type: Polycarbonate
Matériel du corps: Aluminium | Type de diffuseur: Polycarbonate
Material del cuerpo: Aluminio | Tipo de difusor: Policarbonato

Alimentazione

Power supply
Alimentation
Alimentación

220-240 V

Versioni

Versions
Versions
Versiones

Cavo Alimentazione: 1,50 metri H05RN-F 3×1

Power cable: 1.50 m H05RN-F 3×1
Câble d'alimentation: 1,50 m H05RN-F 3×1
Cable de alimentación: 1,50 m H05RN-F 3×1



CNC 100
L



CNC 100
2L



CNC 100
UP



COLOURS



Stainless steel electropolished



White RAL 9010



Grey High Tech RAL 9006









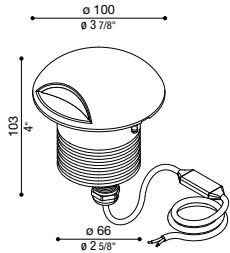

Grey anthracite RAL 7021



Corten

CNC 100 L







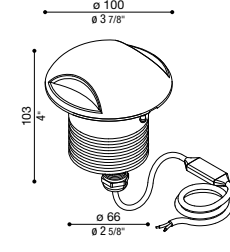

IP67 I K 10 20J xx9 CE UK CA 2000 KG MAX 50°C MAX	LED			COL.	CODE *	
	W	LM	REAL LM			
	3	215	103	 LL123000□  LL123001□  LL123002□  LL123003□  LL123004□	  220-240 V	

Fino ad esaurimento.
Until our stock lasts.
Jusqu'à épuisement de stock.
Hasta el agotamiento del stock.

* Complete the CODE □ LED COLOUR N | 4000K 3 | 3000K 2 | 2700K

Versione ghiera top con apertura a 110°. Cavo H05RN-F 3×1. | Version with Top retaining ring with 110° opening. Cable type H05RN-F 3×1. | Version avec virole Top ouverture à 110°. Câble H05RN-F 3×1. | Versión casquillo Top con apertura a 110°. Cable H05RN-F 3×1.

CNC 100 2L







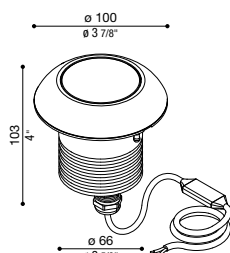

IP67 I K 10 20J xx9 CE UK CA 2000 KG MAX 50°C MAX	LED			COL.	CODE *	
	W	LM	REAL LM			
	5	430	205	 LL123005□  LL123006□  LL123007□  LL123008□  LL123009□	  220-240 V	

Fino ad esaurimento.
Until our stock lasts.
Jusqu'à épuisement de stock.
Hasta el agotamiento del stock.

* Complete the CODE □ LED COLOUR N | 4000K 3 | 3000K 2 | 2700K

Versione ghiera con 2 aperture da 110°. Cavo H05RN-F 3×1. | Version with Top retaining ring with two 110° openings. Cable type H05RN-F 3×1. | Version avec virole Top 2 ouvertures à 110°. Câble H05RN-F 3×1. | Versión casquillo Top con 2 aperturas de 110°. Cable H05RN-F 3×1.

CNC 100 Up

IP67 IK 10 20J xx9 CE UK CA 280 KG MAX 50°C MAX	LED			COL.	CODE *	
	W	LM	REAL LM			
	4	400	217	 LL123010□  LL123011□  LL123012□  LL123013□  LL123014□	  220-240 V	

Fino ad esaurimento.
Until our stock lasts.
Jusqu'à épuisement de stock.
Hasta el agotamiento del stock.

* Complete the CODE □ LED COLOUR N | 4000K 3 | 3000K 2 | 2700K

Emissione luminosa a 120°. Cavo H05RN-F 3×1. | Light beam 120°. Cable type H05RN-F 3×1. | Angle de diffusion 120°. Câble H05RN-F 3×1. | Emissione luminosa a 120°. Cable H05RN-F 3×1.

Armatura da incasso CNC100

Armatura da incasso in termoplastico.

Thermoplastic recess box CNC100

Thermoplastic recess box.

Armature à encastrer CNC100

Armature à encastrer en matériau thermoplastique.

Caja de empotrar CNC100

Caja de empotrar de material termoplástico.

Col.	Code
	LB1230001

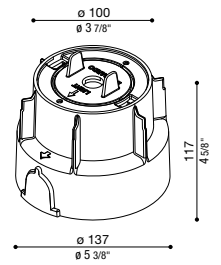

Cavo H05RN-F CNC 3x1

Cavo H05RN-F in Neoprene, sezione 3x1. Adatto ad uso esterno.

Cable type H05RN-F 3x1

Cable type H05RN-F in Neoprene, section 3X1. Suitable for outdoor use.

Câble H05RN-F 3x1

Câble H05RN-F en Néoprène, section 3X1. Egalement adapté à l'usage à l'extérieur.

Cable H05RN-F CNC 3x1

Cable H05RN-F de Neopreno, sección 3X1. Adecuado para el uso al exteriores.

Cavo H05RN-F 5m

Col.	Code
	LB1070054

Cavo H05RN-F 10m

Col.	Code
	LB1070055

Cavo H05RN-F 15m

Col.	Code
	LB1070056

Cavo H05RN-F 20m

Col.	Code
	LB1070057

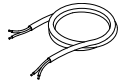

FEATURES

Incasso.
Recessed.
À encastrer.
Empotrado.

Alimentatore
Driver
Ballast
Alimentador

Molla per ancoraggio
Reting springs
Ressort pour ancrage
Muelles de anclaje

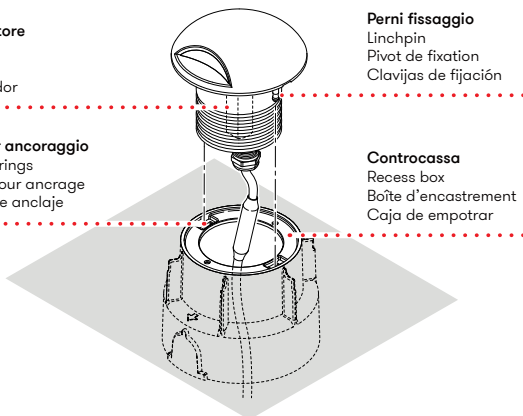

Perni fissaggio
Linchpin
Pivot de fixation
Clavijas de fijación

Controcassa
Recess box
Boîte d'encastrement
Caja de empotrar



Led a tensione di rete.
LED AC Direct.
LED Direct AC.
Led a tensión de red.



Led posto verticalmente.
LED vertically mounted.
LED monté verticalement.
Led colocado verticalmente.



CNC 100 2L



CNC 120

Installazione

Installation
Installation
Instalación

Incasso terra

Ground recess
Encastrément au sol
Empotrar suelo

Materiali

Materials
Materiali
Materiales

Materiale Corpo: Alluminio | Tipo di diffusore: Vetro

Material: Aluminium | Diffuser type: Glass
Matériel du corps: Aluminium | Type de diffuseur: Verre
Material del cuerpo: Aluminio | Tipo de difusor: Cristal

Alimentazione

Power supply
Alimentation
Alimentación

700mA - 12V - 12/24V

Versioni

Versions
Versions
Versiones

Cavo Alimentazione: 1,50 metri H05RN-F 2×0,75

Power cable: 1.50 m H05RN-F 2×0.75
Câble d'alimentation: 1,50 m H05RN-F 2×0,75
Cable de alimentación: 1,50 m H05RN-F 2×0,75



CNC 120

T









COLOURS



Brushed grey

CNC 120 T

IP67 IK 10 20J xx9 CE UK 2000 KG MAX 60°C MAX	LED				COL.	CODE *
	W	LM	REAL LM			
	9	1000	750	  700mA-12V		LL131000□□
	9	1000	750	  12/24V		LL131100□□

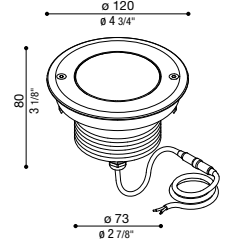

* Complete the CODE ○ OPTIC S | Spot-25° M | 60° A | Asymm. D | Diff. B | Blade □ LED COLOUR N | 4000K 3 | 3000K 2 | 2700K



Alimentatori CNC 120 in corrente costante

CNC 120 ballasts in constant current

Alimentations CNC 120 en courant constant

Alimentadores CNC 120 de corriente constante

N° max	IP	Code
1/2	20	LB1070060
3	20	LB1070061
1/2	67	LB1070059
1/2 1-10V PUSH	20	LB1070043
1/3 DALI	20	LB1070064

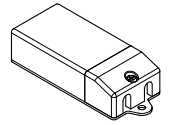

Alimentatori CNC 120 in tensione costante 12/24V

CNC 120 ballasts in constant tension 12/24V

Alimentations en tension CNC120

Alimentadores CNC 120 de tensión constante 12/24V

12V			24V		
N° max	IP	Code	N° max	IP	Code
1/2	20	LB1070025	1/3	20	LB1070029
1/3	20	LB1070026	1/5	20	LB1070030
1/2	67	LB1070027	1/4	67	LB1070031
1/4	67	LB1070028	1/6	67	LB1070032

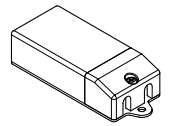

Cavo H05RN-F 2x0,75

Cavo H05RN-F in Neoprene, sezione 2x0,75. Adatto ad uso esterno.

Cable type H05RN-F 2x0,75

Cable type H05RN-F in Neoprene, section 2x0.75. Suitable for outdoor use.

Câble H05RN-F 2x0,75

Câble H05RN-F en Néoprène, section 2x0,75. Également adapté à l'usage à l'extérieur.

Cable H05RN-F 2x0,75

Cable H05RN-F de Neopreno, sección 2x0,75. Adecuado para el uso al exteriores.

Cavo H05RN-F 5m

CoL.	Code
	LB1070004

Cavo H05RN-F 10m

CoL.	Code
	LB1070005

Cavo H05RN-F 15m

CoL.	Code
	LB1070006

Cavo H05RN-F 20m

CoL.	Code
	LB1070007

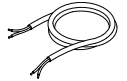

Armatura da incasso CNC 120

Armatura da incasso in termoplastico.

Thermoplastic recess box CNC120

Thermoplastic recess box.

Armature à encastrer CNC120

Armature à encastrer en matériau thermoplastique.

Caja de empotrar CNC120

Caja de empotrar de material termoplástico.

Col.	Code
	LB1310001

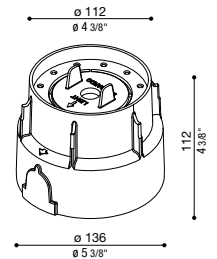



FEATURES

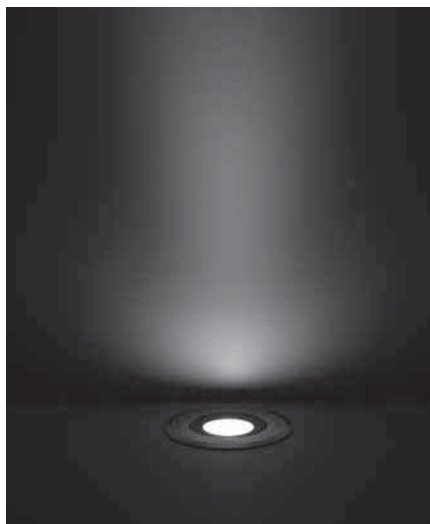

↘ S Spot-25°

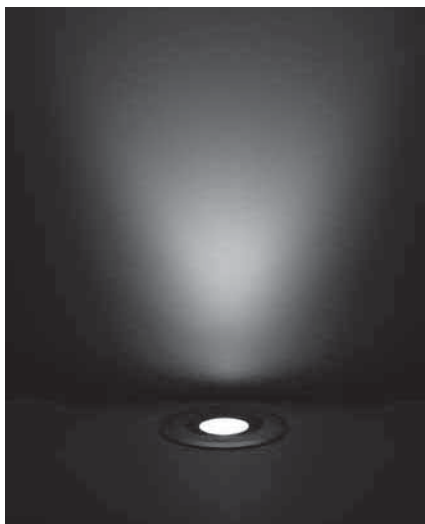

↘ M 60°

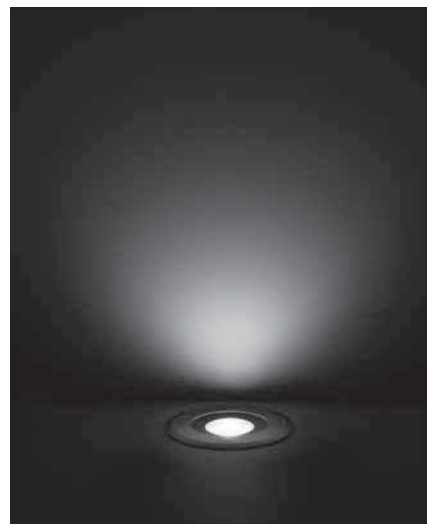

↘ D Diff.

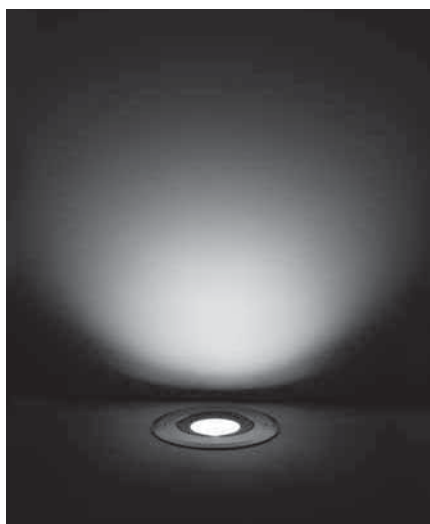

↘ A Asymm.



↘ B Blade

Complete the CODE

○ OPTIC

Completa il codice sostituendo al cerchio grigio la lettera corrispondente al modello di ottica scelta.

Complete the code by replacing the grey circle with the letter corresponding to the chosen optic model.

Compléter le code en remplaçant le cercle gris par la lettre correspondant au modèle de lentille choisie.

Completa el código sustituyendo el círculo gris por la letra correspondiente al modelo de óptica elegido.



CNC 120 T

CNC 150

Installazione

Installation
Installation
Instalación

Incasso terra

Ground recess
Encastrément au sol
Empotrar suelo

Materiali

Materials
Materiali
Materiales

Materiale Corpo: Alluminio | Tipo di diffusore: Vetro

Material: Aluminium | Diffuser type: Glass
Matériel du corps: Aluminium | Type de diffuseur: Verre
Material del cuerpo: Aluminio | Tipo de difusor: Cristal

Alimentazione

Power supply
Alimentation
Alimentación

600mA - 35V

Versioni

Versions
Versions
Versiones

Cavo Alimentazione: 0,50 metri H05RN-F 2x0,75

Power cable: 0.50 m H05RN-F 2x0.75
Câble d'alimentation: 0,50 m H05RN-F 2x0,75
Cable de alimentación: 0,50 m H05RN-F 2x0,75



CNC 150



COLOURS



Brushed grey

CNC 150

IP67 IK 10 20J xx9 CE UK 2000 KG MAX 58°C MAX	LED			COL.	CODE *	
	W	LM	REAL LM			
	20	2800	2480	600mA - 35V	LL136000□□	

* Complete the CODE ○ OPTIC S | 12° M | 24° L | 32° □ LED COLOUR N | 4000K 3 | 3000K 2 | 2700K

Disponibile su richiesta versione a 24V. | 24V version available on request. | Version 24V disponible sur demande. | Versión de 24 V disponible bajo pedido.

Accessori | Accessories | Accessoires

Cavo H05RN-F 2x0,75

Cavo H05RN-F in Neoprene, sezione 2x0,75. Adatto ad uso esterno.

Cable type H05RN-F in Neoprene, section 2x0.75. Suitable for outdoor use.

Câble H05RN-F en Néoprène, section 2x0,75. Également adapté à l'usage à l'extérieur.

Cable H05RN-F de Neopreno, sección 2x0,75. Adecuado para el uso al exteriores.

5m	15m
Code	Code
LB1070004	LB1070006
10m	20m
Code	Code
LB1070005	LB1070007



Armatura da incasso CNC 150

Armatura da incasso in termoplastico.

Thermoplastic recess box CNC 150.

Armature à encastrer en matériau thermoplastique CNC 150.

Caja de empotrar de material termoplástico CNC 150.

Col.	Code
-	LB1360001

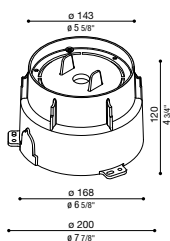

Alimentatori CNC 150 in corrente costante

Drivers in constant current CNC150

Alimentations à courant constant CNC 150

Alimentadores de corriente constante CNC 150

N° max	IP	Code
1	20	LB1070063
1 DALI	20	LB1070064
1	67	LB1070112

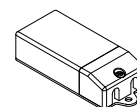

CNC 150



CNC 25

Installazione

Installation
Installation
Instalación

Incasso parete - Incasso soffitto - Incasso terra

Wall recess - Ceiling recess - Ground recess
Encastrement au mur - Encastrement au plafond - Encastrement au sol
Empotrar pared - Empotrar techo - Empotrar suelo

Materiali

Materials
Materiali
Materiales

Materiale Corpo: Acciaio AISI316L | Tipo di diffusore: Vetro

Material: Stainless steel AISI316L | Diffuser type: Glass
Matériel du corps: Acier inox AISI316L | Type de diffuseur: Verre
Material del cuerpo: Acero AISI316L | Tipo de difusor: Cristal

Alimentazione

Power supply
Alimentation
Alimentación

500mA - 4,8V - 12/24V

Versioni

Versions
Versions
Versiones

Cavo Alimentazione: 1,50 metri H05RN-F 2×0,75

Power cable: 1.50 m H05RN-F 2×0.75
Câble d'alimentation: 1,50 m H05RN-F 2×0,75
Cable de alimentación: 1,50 m H05RN-F 2×0,75



CNC 25
T



CNC 25
Q



COLOURS



Polished stainless steel









Grey anthracite RAL 7021



Corten

CNC 25 T

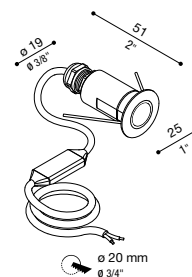

IP67 IK 10 20J xx9 CE UK CR 500 KG MAX 65°C MAX	LED			COL.	CODE *
	W	LM	REAL LM		
 Fino ad esaurimento. Until our stock lasts. Jusqu'à épuisement de stock. Hasta el agotamiento del stock.	2	180	Max 148	  	LL119000□□ LL119004□□ LL119006□□
	2	180	Max 148	  	LL119001□□ LL119005□□ LL119007□□



* Complete the CODE ○ OPTIC S | 15° M | 30° D | Diff. □ LED COLOUR N | 4000K 3 | 3000K 2 | 2700K B | Blue

Idoneo per installazione in tubo corrugato standard Ø25 mm. | Suitable for installation in standard Ø 25 mm corrugated duct. | Convient pour une installation dans un tube annelé standard Ø25 mm. | Adecuado para instalación en tubo corrugado estándar Ø 25 mm.

CNC 25 Q

IP67 IK 10 20J xx9 CE UK CR 500 KG MAX 65°C MAX	LED			COL.	CODE *
	W	LM	REAL LM		
 Fino ad esaurimento. Until our stock lasts. Jusqu'à épuisement de stock. Hasta el agotamiento del stock.	2	180	Max 148		LL119002□□
	2	180	Max 148		LL119003□□

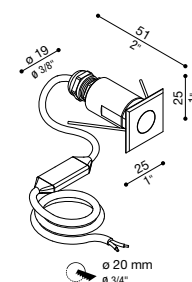

* Complete the CODE ○ OPTIC S | 15° M | 30° D | Diff. □ LED COLOUR N | 4000K 3 | 3000K 2 | 2700K B | Blue

Idoneo per installazione in tubo corrugato standard Ø25 mm. | Suitable for installation in standard Ø 25 mm corrugated duct. | Convient pour une installation dans un tube annelé standard Ø25 mm. | Adecuado para instalación en tubo corrugado estándar Ø 25 mm.

Alimentatori CNC 25 in corrente costante

CNC 25 ballasts in constant current	350mA			500mA		
	N° max	IP	Code	N° max	IP	Code
Alimentations CNC 25 en courant constant	1/2	20	LB1070008	1/2	20	LB1070015
	1/4	20	LB1070009	1/4	20	LB1070016
Alimentadores CNC 25	5/10	20	LB1070011	5/10	20	LB1070018
	1/2 1-10V PUSH	20	LB1070012	1/12 1-10V PUSH	20	LB1070019
	2/4	67	LB1070013	1/4	67	LB1070020
	5/10	67	LB1070014	5/10	67	LB1070021
	2/9 DALI	20	LB1070064	2/9 DALI	20	LB1070064
				1/7 1-10V PUSH	20	LB1070043

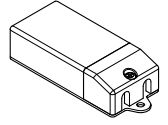

Alimentatori CNC 25 in tensione costante 12/24V

CNC 25 ballasts in constant tension 12/24V	12V			24V		
	N° max	IP	Code	N° max	IP	Code
Alimentations CNC 25 en tension 12/24V	1/6	20	LB1070025	1/6	20	LB1070029
	1/12	20	LB1070026	1/12	20	LB1070030
	1/8	67	LB1070027	1/8	67	LB1070031
Alimentadores CNC 25 de tensión constante 12/24V	1/15	67	LB1070028	1/15	67	LB1070032

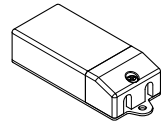

Cavo H05RN-F 2x0,75

Cavo H05RN-F in Neoprene, sezione 2x0,75.
Adatto ad uso esterno.

Cable type H05RN-F 2x0,75

Cable type H05RN-F in Neoprene, section 2x0.75.
Suitable for outdoor use.

Câble H05RN-F 2x0,75

Câble H05RN-F en Néoprène, section 2x0,75.
Également adapté à l'usage à l'extérieur.

Cable H05RN-F 2x0,75

Cable H05RN-F de Neopreno, sección 2x0,75.
Adecuado para el uso al exteriores.

Cavo H05RN-F 5m

CoL.	Code
	LB1070004

Cavo H05RN-F 10m

CoL.	Code
	LB1070005

Cavo H05RN-F 15m

CoL.	Code
	LB1070006

Cavo H05RN-F 20m

CoL.	Code
	LB1070007



Armatura da incasso CNC25

Armatura da incasso in termoplastico.

Thermoplastic recess box CNC25

Thermoplastic recess box.

Armature à encastrer CNC25

Armature à encastrer en matériau thermoplastique.

Caja de empotrar CNC25

Caja de empotrar de material termoplástico.

CoL.	Code
	LB1190001

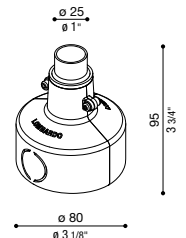



CNC 35

Installazione

Installation
Installation
Instalación

Incasso parete - Incasso soffitto - Incasso terra - Parete - Terra

Wall recess - Ceiling recess - Ground recess - Wall - Ground
Encastrement au mur - Encastrement au plafond - Encastrement au sol - Mur - Sol
Empotrar pared - Empotrar techo - Empotrar suelo - Pared - Suelo

Materiali

Materials
Materiali
Materiales

Materiale Corpo: Acciaio AISI316L | Tipo di diffusore: Vetro

Material: Stainless steel AISI316L | Diffuser type: Glass
Matériel du corps: Acier inox AISI316L | Type de diffuseur: Verre
Material del cuerpo: Acero AISI316L | Tipo de difusor: Cristal

Alimentazione

Power supply
Alimentation
Alimentación

500mA - 4,8V - 12/24V

Versioni

Versions
Versions
Versiones

Cavo Alimentazione: 1,50 metri H05RN-F 2×0,75

Power cable: 1.50 m H05RN-F 2×0.75
Câble d'alimentation: 1,50 m H05RN-F 2×0,75
Cable de alimentación: 1,50 m H05RN-F 2×0,75



CNC 35
T



CNC 35 T
UP



CNC 35
Q



CNC 35
Q UP



CNC 35
TOP S



CNC 35
TOP L



CNC 35
MASK



CNC 35
SWING



CNC 35
SWING SPOT

COLOURS



Polished stainless steel











Grey anthracite RAL 7021



Corten



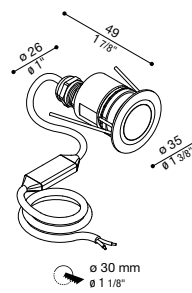

CNC 35 T

<p>IP 67 IK 10 20J xx9 CE UK CA 500 KG MAX 65°C MAX</p>  <p>Fino ad esaurimento. Until our stock lasts. Jusqu'à épuisement de stock. Hasta el agotamiento del stock.</p>	LED				COL.	CODE *
	W	LM	REAL LM			LL107000□□
	2	180	Max 148			LL107032□□
						LL107033□□
					LL107006□□	
					LL107034□□	
					LL107035□□	



* Complete the CODE OPTIC S | 14° M | 29° L | 46° D | Diff. LED COLOUR N | 4000K 3 | 3000K 2 | 2700K B | Blue

CNC 35 T Up



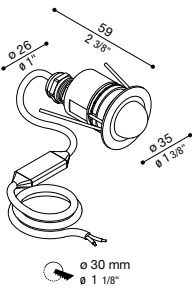

<p>IP 67 IK 10 20J xx9 CE UK CA 1000 KG MAX 65°C MAX</p>  <p>Fino ad esaurimento. Until our stock lasts. Jusqu'à épuisement de stock. Hasta el agotamiento del stock.</p>	LED				COL.	CODE *
	W	LM	REAL LM			LL107024□
	2	180	78			
						LL107025□
						



* Complete the CODE LED COLOUR N | 4000K 3 | 3000K 2 | 2700K B | Blue

Versione con diffusore in vetro sporgente ad alta diffondenza. | Version with protruding glass diffuser for high diffusion. | Version avec diffuseur en verre saillant à diffusion élevée. | Versión con difusor de vidrio sobresaliente de alta difusión.



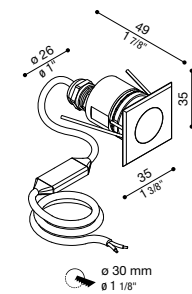

CNC 35 Q

<p>IP 67 IK 10 20J xx9 CE UK CA 500 KG MAX 65°C MAX</p>  <p>Fino ad esaurimento. Until our stock lasts. Jusqu'à épuisement de stock. Hasta el agotamiento del stock.</p>	LED				COL.	CODE *
	W	LM	REAL LM			LL107001□□
	2	180	Max 148			
						LL107007□□
						



* Complete the CODE OPTIC S | 14° M | 29° L | 46° D | Diff. LED COLOUR N | 4000K 3 | 3000K 2 | 2700K B | Blue

CNC 35 Q Up



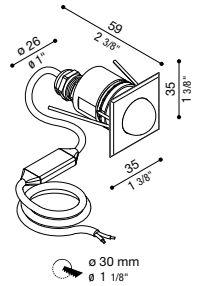

IP67 I K 10 20J xx9 CE UK CA 1000 KG MAX 65°C MAX	LED		W	LM	REAL LM	COL.	CODE *
	W	LM					
 Fino ad esaurimento. Until our stock lasts. Jusqu'à épuisement de stock. Hasta el agotamiento del stock.	2	180	78		500mA-4,8V		LL107026□
	2	180	78		12/24V		LL107027□



* Complete the CODE □ LED COLOUR N | 4000K 3 | 3000K 2 | 2700K B | Blue

Versione con diffusore in vetro sporgente ad alta diffondenza. | Version with protruding glass diffuser for high diffusion. | Version avec diffuseur en verre saillant à diffusion élevée. | Versión con difusor de vidrio sobresaliente de alta difusión.

CNC 35 Top S



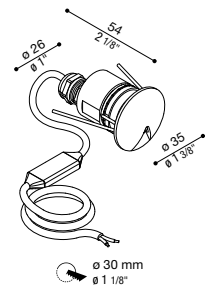

IP67 IK 10 20J xx9 CE UK CA 500 KG MAX 65°C MAX	LED		W	LM	REAL LM	COL.	CODE *
	W	LM					
 Fino ad esaurimento. Until our stock lasts. Jusqu'à épuisement de stock. Hasta el agotamiento del stock.	2	180	12		500mA-4,8V		LL107002□
	2	180	12		12/24V		LL107008□



* Complete the CODE □ LED COLOUR N | 4000K 3 | 3000K 2 | 2700K B | Blue

Versione ghiera Top con apertura a 45°. | Version with Top retaining ring with 45° opening. | Version avec virole Top ouverture à 45°. | Versión casquillo Top con apertura a 45°.

CNC 35 Top L

IP67 IK 10 20J xx9 CE UK CA 500 KG MAX 65°C MAX	LED		W	LM	REAL LM	COL.	CODE *
	W	LM					
 Fino ad esaurimento. Until our stock lasts. Jusqu'à épuisement de stock. Hasta el agotamiento del stock.	2	180	25		500mA-4,8V		LL107003□
	2	180	25		12/24V		LL107009□

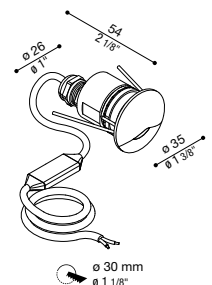

* Complete the CODE □ LED COLOUR N | 4000K 3 | 3000K 2 | 2700K B | Blue

Versione ghiera top con apertura a 135°. | Version with Top retaining ring with 135° opening. | Version avec virole Top ouverture à 135°. | Versión casquillo Top con apertura a 135°.

CNC 35 Mask

IP67 IK 10 20J xx9 CE UK 500 KG MAX 65°C MAX	LED		W	LM	REAL LM	COL.	CODE *
	2	180	21	500mA-4,8V	LL107004		
Fino ad esaurimento. Until our stock lasts. Jusqu'à épuisement de stock. Hasta el agotamiento del stock.	2	180	21	12/24V	LL107010		

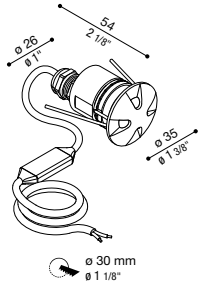

* Complete the CODE □ LED COLOUR N | 4000K 3 | 3000K 2 | 2700K B | Blue

Versione ghiera Mask con 4 aperture da 35°. | Version with Mask retaining ring with four 35° openings. | Version avec virole Mask 4 ouvertures à 35°. | Versión casquillo Mask con 4 aperturas de 35°.

CNC 35 Swing

IP67 IK 07 2J xx5 CE UK 65°C MAX	LED		W	LM	REAL LM	COL.	CODE *
	2	180	Max 148	500mA-4,8V	LL107005 □ LL107036 □ LL107037 □		
Fino ad esaurimento. Until our stock lasts. Jusqu'à épuisement de stock. Hasta el agotamiento del stock.	2	180	Max 148	12/24V	LL107011 □ LL107038 □ LL107039 □		

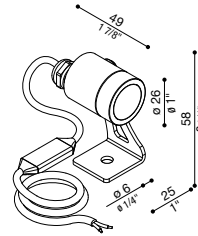

* Complete the CODE ○ OPTIC S | 14° M | 29° L | 46° D | Diff. □ LED COLOUR N | 4000K 3 | 3000K 2 | 2700K B | Blue

Versione orientabile. Picchetto non incluso. | Swivel version. Stake not included. | Version orientable. Piquet non compris. | Versión orientable. Piquete no incluido.

CNC 35 Swing Spot

IP67 IK 07 2J xx5 CE UK 65°C MAX	LED		W	LM	REAL LM	COL.	CODE *
	2	180	Max 148	500mA-4,8V	LL107028		
Fino ad esaurimento. Until our stock lasts. Jusqu'à épuisement de stock. Hasta el agotamiento del stock.	2	180	Max 148	12/24V	LL107029		

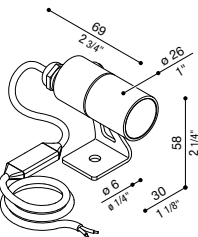

* Complete the CODE □ LED COLOUR N | 4000K 3 | 3000K 2 | 2700K B | Blue

Versione orientabile antiabbagliamento. Picchetto non incluso. | Adjustable anti-glare version. Stake not included. | Version orientable antiéblouissement. Piquet non compris. | Versión orientable antiencandilamiento. Estaca no incluida.

Armatura da incasso CNC 35

Armatura da incasso in termoplastico.

Thermoplastic recess box CNC 35

Thermoplastic recess box.

Armature à encastrer CNC 35

Armature à encastrer en matériau thermoplastique.

Caja de empotrar CNC 35

Caja de empotrar de material termoplástico.

Col. Code

LB1070001

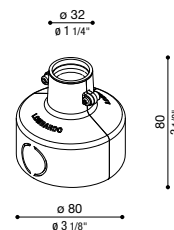

Alimentatori CNC 35 in corrente costante

CNC 35 ballasts in constant current

350mA

N° max	IP	Code
1/2	20	LB1070008
1/4	20	LB1070009
5/10	20	LB1070011
1/2 1-10V PUSH	20	LB1070012
2/4	67	LB1070013
5/10	67	LB1070014
2/9 DALI	20	LB1070064

500mA

N° max	IP	Code
1/2	20	LB1070015
1/4	20	LB1070016
5/10	20	LB1070018
1/12 1-10V PUSH	20	LB1070019
1/4	67	LB1070020
5/10	67	LB1070021
2/9 DALI	20	LB1070064
1/7 1-10V PUSH	20	LB1070043

Alimentations

CNC 35

en courant constant

Alimentadores

CNC 35

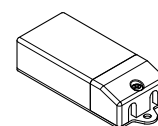

Alimentatori CNC 35 in tensione costante 12/24V

CNC 35 ballasts in constant tension 12/24V

12V

N° max	IP	Code
1/6	20	LB1070025
1/12	20	LB1070026
1/8	67	LB1070027
1/15	67	LB1070028

24V

N° max	IP	Code
1/6	20	LB1070029
1/12	20	LB1070030
1/8	67	LB1070031
1/15	67	LB1070032

Alimentations

CNC 35

en tension 12/24V

Alimentadores

CNC 35

de tensión constante 12/24V

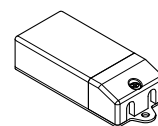

Cavo H05RN-F 2x0,75

Cavo H05RN-F in Neoprene, sezione 2x0,75. Adatto ad uso esterno.

Cable type H05RN-F 2x0,75

Cable type H05RN-F in Neoprene, section 2x0.75. Suitable for outdoor use.

Câble H05RN-F 2x0,75

Câble H05RN-F en Néoprène, section 2x0.75. Également adapté à l'usage à l'extérieur.

Cable H05RN-F 2x0,75

Cable H05RN-F de Neopreno, sección 2x0.75. Adecuado para el uso al exteriores.

Cavo H05RN-F 5m

Col.	Code
	LB1070004

Cavo H05RN-F 10m

Col.	Code
	LB1070005

Cavo H05RN-F 15m

Col.	Code
	LB1070006

Cavo H05RN-F 20m

Col.	Code
	LB1070007

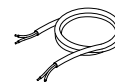

Accessorio giardino per CNC

Accessorio da giardino da abbinare a CNC35 Swing, realizzato in metallo zincato a freddo. Adatto per uso esterno. Idoneo per installazione a terra.

Garden accessory - CNC35

Garden accessory for use with CN C35 Swing, made of cold galvanized metal. Suitable for outdoor use and ground application.

Accessoire de jardin - CNC35

Accessoire de jardin à associer à CNC35 Swing, réalisé en métal zingué à froid. Également adapté à l'usage à l'extérieur. Convient pour une utilisation au sol.

Accesorio para jardín - CNC35

Accesorio de jardín a acoplar a CNC35 Swing, realizado en metal galvanizado en frío. Adecuado para el uso al exteriores. Idóneo para instalación en el suelo.

Col. Code

LB1070002

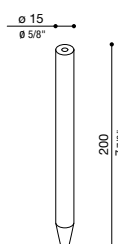



CNC 35 T

CNC 50

Installazione

Installation
Installation
Instalación

Incasso parete - Incasso soffitto - Incasso terra - Parete - Terra

Wall recess - Ceiling recess - Ground recess - Wall - Ground
Encastrement au mur - Encastrement au plafond - Encastrement au sol - Mur - Sol
Empotrar pared - Empotrar techo - Empotrar suelo - Pared - Suelo

Materiali

Materials
Materiali
Materiales

Materiale Corpo: Acciaio AISI316L | Tipo di diffusore: Vetro

Material: Stainless steel AISI316L | Diffuser type: Glass
Matériel du corps: Acier inox AISI316L | Type de diffuseur: Verre
Material del cuerpo: Acero AISI316L | Tipo de difusor: Cristal

Alimentazione

Power supply
Alimentation
Alimentación

500mA - 14V - 24V

Versioni

Versions
Versions
Versiones

Cavo Alimentazione: 1,50 metri H05RN-F 2×0,75

Power cable: 1.50 m H05RN-F 2×0.75
Câble d'alimentation: 1,50 m H05RN-F 2×0,75
Cable de alimentación: 1,50 m H05RN-F 2×0,75



CNC 50
T



CNC 50
T UP



CNC 50
TOP L



CNC 50
TOP 2L



CNC 50
SWING



CNC 50
SWING SPOT

COLOURS



Polished stainless steel



Grey anthracite RAL 7021



Corten

CNC 50 T

IP67 I K 10 20J xx9 CE UK 500 KG MAX 65°C MAX	LED		W	LM	REAL LM	COL.	CODE *
	6,5	650	Max 427	⊠ ⊗	500mA-14V	<input type="checkbox"/> LL107016 <input type="checkbox"/> LL107040 <input type="checkbox"/> LL107041	
6,5	650	Max 427	⊠ ⊗	24V	<input type="checkbox"/> LL107017 <input type="checkbox"/> LL107042 <input type="checkbox"/> LL107043		

Fino ad esaurimento.
 Until our stock lasts.
 Jusqu'à épuisement de stock.
 Hasta el agotamiento del stock.

★ Complete the CODE OPTIC S | 13° M | 24° L | 53° D | Diff. LED COLOUR N | 4000K 3 | 3000K 2 | 2700K

CNC 50 T Up

IP67 IK 10 20J xx9 CE UK 450 KG MAX 65°C MAX	LED		W	LM	REAL LM	COL.	CODE *
	6,5	650	269	⊠ ⊗	500mA-14V	<input type="checkbox"/> LL107022	
6,5	650	269	⊠ ⊗	24V	<input type="checkbox"/> LL107023		

Fino ad esaurimento.
 Until our stock lasts.
 Jusqu'à épuisement de stock.
 Hasta el agotamiento del stock.

★ Complete the CODE LED COLOUR N | 4000K 3 | 3000K 2 | 2700K

Versione con diffusore in vetro sporgente ad alta diffondenza. | Version with protruding glass diffuser for high diffusion. | Version avec diffuseur en verre saillant à diffusion élevée. | Versión con difusor de vidrio sobresaliente de alta difusión.

CNC 50 Top L

IP67 IK 10 20J xx9 CE UK 65°C MAX 2000 KG MAX	LED		W	LM	REAL LM	COL.	CODE *
	6,5	650	260	⊠ ⊗	500mA-14V	<input type="checkbox"/> LL107018	
6,5	650	260	⊠ ⊗	24V	<input type="checkbox"/> LL107019		

Fino ad esaurimento.
 Until our stock lasts.
 Jusqu'à épuisement de stock.
 Hasta el agotamiento del stock.

★ Complete the CODE LED COLOUR N | 4000K 3 | 3000K 2 | 2700K

Versione ghiera top con apertura a 110°. | Version with Top retaining ring with 110° opening. | Version avec virole Top ouverture à 110°. | Versión casquillo Top con apertura a 110°.

CNC 50 Top 2L

IP67 IK 10 20J xx9 CE UK CA 2000 KG MAX 65°C MAX	LED		COL.		CODE *
	W	LM	REAL LM		
	6,5	650	453	⊠ ⊗ 500mA-14V	
6,5	650	453	⊠ ⊗ 24V		LL107021□

Fino ad esaurimento.
Until our stock lasts.
Jusqu'à épuisement de stock.
Hasta el agotamiento del stock.

* Complete the CODE □ LED COLOUR N | 4000K 3 | 3000K 2 | 2700K

Versione ghiera con 2 aperture da 110°. | Version with Top retaining ring with two 110° openings. | Version avec virole Top 2 ouvertures à 110°. | Versión casquillo Top con 2 aperturas de 110°.

CNC 50 Swing

IP67 IK 07 2J xx5 CE UK CA 65°C MAX	LED		COL.		CODE *
	W	LM	REAL LM		
	6,5	650	Max 427	⊠ ⊗ 500mA-14V	
6,5	650	Max 427	⊠ ⊗ 24V	 	LL107013□ LL107046□ LL107047□

Fino ad esaurimento.
Until our stock lasts.
Jusqu'à épuisement de stock.
Hasta el agotamiento del stock.

* Complete the CODE ○ OPTIC S | 13° M | 24° L | 53° D | Diff. □ LED COLOUR N | 4000K 3 | 3000K 2 | 2700K

Versione orientabile. Picchetto non incluso. | Swivel version. Stake not included. | Version orientable. Piquet non compris. | Versión orientable. Piquete no incluido.

CNC 50 Swing Spot

IP67 IK 07 2J xx5 CE UK CA 65°C MAX	LED		COL.		CODE *
	W	LM	REAL LM		
	6,5	650	Max 488	⊠ ⊗ 500mA-14V	
6,5	650	Max 488	⊠ ⊗ 24V		LL107031□

Fino ad esaurimento.
Until our stock lasts.
Jusqu'à épuisement de stock.
Hasta el agotamiento del stock.

* Complete the CODE □ LED COLOUR N | 4000K 3 | 3000K 2 | 2700K

Versione orientabile antiabbagliamento. Picchetto non incluso. | Adjustable anti-glare version. Stake not included. | Version orientable antiéblouissement. Piquet non compris. | Versión orientable antiencañilamiento. Estaca no incluida.

Alimentatori CNC 50 in corrente costante

CNC 50 ballasts in constant current	350mA			500mA		
	N° max	IP	Code	N° max	IP	Code
Alimentations CNC 50 en courant constant	1	20	LB1070009	1	20	LB1070016
	1/3	20	LB1070011	1/3	20	LB1070018
Alimentadores CNC 50	1/3 1-10V PUSH	20	LB1070012	1/3 1-10V PUSH	20	LB1070019
	1/2	67	LB1070013	1/2	67	LB1070020
	1/3	67	LB1070014	2/4	67	LB1070021
	1/3 DALI	20	LB1070064	1/3 DALI	20	LB1070064

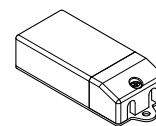

Alimentatori CNC 50 in tensione costante 24V

CNC 50 ballasts in constant tension 24V available	N° max	IP	Code
Alimentations CNC 50 en tension 24V	1/2	20	LB1070029
	1/4	20	LB1070030
Alimentadores CNC 50 de tensión constante 24V	1/5	67	LB1070031
	1/7	67	LB1070032

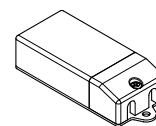

Cavo H05RN-F 2x0,75

Cavo H05RN-F in Neoprene, sezione 2x0,75. Adatto ad uso esterno.

Cable type H05RN-F 2x0,75

Cable type H05RN-F in Neoprene, section 2x0.75. Suitable for outdoor use.

Câble H05RN-F 2x0,75

Câble H05RN-F en Néoprène, section 2x0.75. Également adapté à l'usage à l'extérieur.

Cable H05RN-F 2x0,75

Cable H05RN-F de Neopreno, sección 2x0.75. Adecuado para el uso al exteriores.

Cavo H05RN-F 5m

Col.	Code
	LB1070004

Cavo H05RN-F 10m

Col.	Code
	LB1070005

Cavo H05RN-F 15m

Col.	Code
	LB1070006

Cavo H05RN-F 20m

Col.	Code
	LB1070007

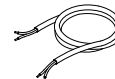

Armatura da incasso CNC 50

Armatura da incasso in termoplastico.

Recess box CNC 50

Thermoplastic recess box.

Boîte d'encastrement CNC 50

Armature à encastrer en matériau thermoplastique.

Caja de empotrar CNC 50

Caja de empotrar de material termoplástico.

Col.	Code
	LB1070039

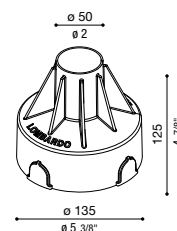

Accessorio giardino per CNC

Accessorio da giardino da abbinare a CNC50 Swing, realizzato in metallo zincato a freddo. Adatto per uso esterno. Idoneo per installazione a terra.

Garden accessory - CNC50

Garden accessory for use with CNC50 Swing, made of cold galvanized metal. Suitable for outdoor use and ground application.

Accessoire de jardin - CNC50

Accessoire de jardin à associer à CNC50 Swing, réalisé en métal zingué à froid. Également adapté à l'usage à l'extérieur. Convient pour une utilisation au sol.

Accesorio para jardín - CNC50

Accesorio de jardín a acoplar a CNC50 Swing, realizado en metal galvanizado en frío. Adecuado para el uso al exteriores. Idóneo para instalación en el suelo.

Col.	Code
	LB1070002

